

# UNI-T®



## UT139A/B/C

### Operating Manual



True RMS Digital Multimeters



P/N: 110401104116X  
MAY.2018 REV. 1

**Table of Contents**

I. Overview .....	1
II. Accessory .....	1
III. Safety Operation Regulation .....	1
IV. Electric Symbol .....	2
V. Comprehensive Specification .....	3
VI. Appearance Structure .....	4
VII. LCD Display .....	5
VIII. Knobs and Keys for Range Selection .....	7
IX. Measurement Instruction .....	9
X. Technical Index .....	16
XI. Upkeep and Maintenance .....	22

## I. Overview

UT139A/B/C DMM is a small auto range, hand-held 3 1/2~3 5/6 bit true RMS multimeter featuring complete function, novel structure, high reliability and safety as well as large screen for display . It can be used for measuring AC/DC voltage and current, variable frequency voltage (V.F.C), resistance, diode, circuit on-off, capacitance, frequency ratio, NCV non-contact AC voltage sensing and so on, is an ideal portable maintenance instrument for users.

## II. Accessory

Unpack and take out the instrument, please check following attachments carefully for completeness or intactness. In case of any shortage or damage, please contact with your supplier.

1. An operating instruction manual
2. A test pen (CAT III 600V)10 A
3. Point-type K( nickel chromium~nickel silicon) thermocouple (UT139C only)
4. An optional current clamp (UT139C only)

## III. Safety Information

UT139A/B/C is designed in compliance with standards such as IEC/EN61010-1, pollution grade II, overvoltage (CATIII600V) and double insulation standards. Please comply with operation instruction specified in the Manual; otherwise the protection provided by the instrument may be affected.

CE:This Meter complies with the standards EN 61010-1,EN 61010-2-030: in pollution degree 2, overvoltage category (CAT III 600V) and double insulation.











ETL/cETL: CONFORMS TO UL STD 61010-1, 61010-2-030

CERTIFIED TO CSA STD C22.2 No. 61010-1, 61010-2-030

1. It is forbidden to use the product without having rear cap in place, or otherwise there will be electric shocking.
2. Prior to use, inspect the insulation layer of test pen for intactness, confirming no breakage and broken line.
3. When LCD display shows the icon “”, it is required to replace the battery in time to ensure the measurement accuracy.

4. Range switch shall be set at the correct measurement position.
5. In case of electric shock and damage to the instrument, signals being measured shall not exceed rated limit value.
6. To prevent any damage to the instrument, it is forbidden to change the gear of range switch in measurement.
7. After each measurement, disconnect table pen and the circuit being measured; after the current measurement, especially the measurement of large current, it is necessary to power off before disconnecting table pen and the circuit being measured.
8. In case of electric shock, it is required to be cautious when voltage being measured higher than DC 60V or AC 30Vrms.
9. Do not use the product in high-temperature or high-humidity environment, particularly in the damp environment in where the instrument performance may be severely degraded
10. Refrain from changing the internal wiring in the clamp ammeter to guard against damage to the meter and danger.
11. Clean the meter case with damp cloth and mild detergent rather than the abrasive material and solvent.

## IV. Electric Symbol

	Low electricity of internal battery
	Buzzing On-off
	Diode
	AC/DC
	Warning
	Battery to be measured
	Grounding
	Current clamp
	Double Insulation
	Comply with European Union directive
	This symbol signify the product comply with both USA and Canada requirement

## V. Comprehensive Specification

- Maximum voltage between input terminal and grounding: see instruction about each input terminal protection voltage.
- 10A terminal (CE) is equipped with:  
F 10A H 600V fast-acting fuse (Φ6x25) mm
- mA/μA terminal (CE) is equipped with:  
UT139A-FF 0.2A H 600V fast-acting fuse (Φ6x32) mm  
UT139B-FF 0.5A H 600V fast-acting fuse (Φ6x32) mm  
UT139C-FF 0.6A H 600V fast-acting fuse (Φ6x32) mm
- Maximum display: (UT139A): 1999; (UT139B): 4000; (UT139C): 6000 Refresh 2~3 times per second, display "OL" in case of overrange .  
Capacitance and frequency (only applicable for UT139B/C): 9999 count.  
Duty ratio (only applicable for UT139B/C): 1~99.9%  
Diode: about 2.1V (UT139A) and 3.2V(UT139B/C), displaying "OL" in case of overrange.  
Range: auto/manual  
Polarity: auto  
Working temperature: 0℃~40℃  
Relative humidity: ≤75% when 0℃~30℃, and ≤50% when 30℃~40℃  
Storage temperature: -10℃~50℃
- Electromagnetic compatibility:  
In 1V/m radio frequency (RF) field: Overall accuracy=specified accuracy + 5% of range, and no specified index for RF over 1V/m.
- Operating ASL: 0~2000m
- Internal battery: AA R6P 1.5V×2
- Low electricity: LCD displays "".
- Contour dimension: about (175×80×48.5) mm
- Weight: about 350g (inclusive of battery)
- Safety Standard: IEC/EN 61010-1: CATIII600V; Pollution grade II
- Accreditation: CE

## VI. Appearance Structure (See Figure 1)

- Case
- LCD Display
- 3/4/7.: Selection buttons
- Range Switch
- Measuring input terminal

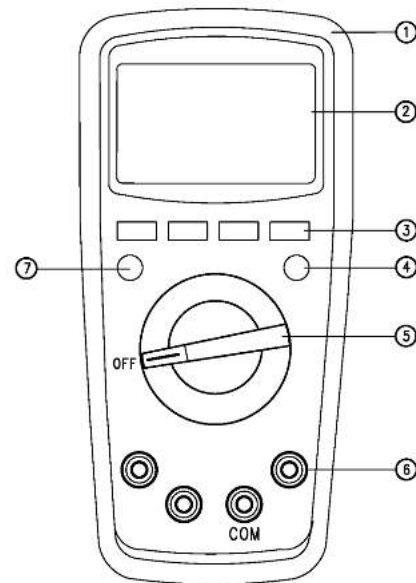
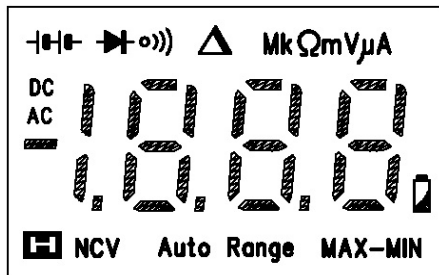

Figure 1

## VII. LCD Display (See Figure 2)

139A-LCD:



139B/C-LCD:

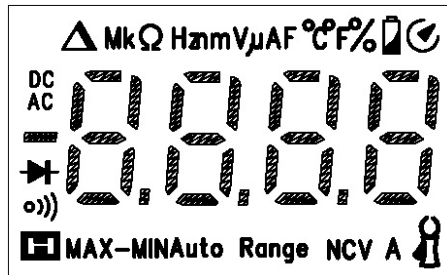

	Symbol	Instruction
1		Data hold prompt
2		Negative reading
3	AC/DC	AC/DC measurement prompt
4	MAX-MIN	Maximum/Minimum/Maximum-Minimum value measurement prompt
5		Under-voltage internal battery
6	Auto Range	Automatic range prompt

7		Diode measurement prompt
8		Circuit on-off measurement prompt
9		Relative measurement prompt
10	Ω/kΩ/MΩ	Resistance units: Ohm, Kilohm and Megohm
11	Hz/kHz/MHz	frequency units: Hz, kHz, MHz
12	%	Duty ratio measurement unit
13	mV/V	Voltage units: mV, V
14	μA/mA/A	Current units: μA, mA, A
15	nF/μF/mF	Capacitance units: nF, μF, mF
16	°C	Centigrade temperature unit
17	°F	Fahrenheit temperature unit
18	(EF)NCV	Non-contact AC voltage sensing
19		Auto power-off prompt
20		Current clamp

### VIII. Knobs and Keys for Range selection

Range Location	Function
$V\sim$ , $V\overline{\sim}$ , $V\overline{\sim}$	AC or DC voltage measurement
$\Omega$	Resistance measurement
$\rightarrow $	Measurement of diode PN junction voltage
$\bullet )$	Measurement of circuit on-off
$\overline{)} $	Capacitance measurement
Hz	Frequency measurement
%	Duty ratio measurement
$^{\circ}C$ / $\square$	Temperature measurement
$\mu A\overline{\sim}$ $mA\overline{\sim}$ $10A\overline{\sim}$	AC/DC current measurement
$60A\overline{\sim}$ $\overline{)} $	AC/DC current clamp measurement
NCV	Non-contact AC voltage sensing
OFF	Switch off internal electric power

#### Button:

**RANGE button:** it can be used for selecting auto/manual range. After pressing, it will switch one gear of switch, when reading the highest gear, jump to the lowest gear range and in turn. When the time of pressing button is  $\geq 2s$  or switching a range, you'll exit the manual range mode. (Only applicable for  $V\overline{\sim}/\Omega/I\overline{\sim}$ )

#### MAX/MIN button:

it can be used to automatically enter the manual range mode. In such case, auto shutdown function is disabled and maximum value is displayed, after another pressing on the button, the minimum value will be displayed and values are displayed in turn (maximum value-minimum value). When the time of pressing button is  $\geq 2s$  or switching a range, you'll exit data recording mode (only applicable for  $V\overline{\sim}$ ,  $\Omega$ ,  $I\overline{\sim}$  and  $^{\circ}C/^{\circ}F$ )

#### REL button:

it can be used to automatically enter the manual range mode. The current displayed value will be taken as the reference value and then the difference between the measured value and reference value will be displayed, after another press, you'll exit the relative measurement mode. (Only applicable for  $V\overline{\sim}$ ,  $\Omega$ ,  $I\overline{\sim}$ ,  $^{\circ}C/^{\circ}F$  and  $\overline{)}|$ )

The backlight will be illuminated when the time of pressing button is  $\geq 2s$ , after about 15s, the backlight will be automatically turned off; the backlight will be turned off if pressing the key  $\geq 2s$  when the backlight is illuminated, (Only applicable for UT139A full range: REL/LIGHT button)

#### NCV/mV $\sim$ button (Only applicable for UT139A):

It can be used to switch NCV/mV $\sim$ . For detailed information, see the operation instruction for non-contact AC voltage sensing.

#### Hz/% button (only applicable for UT139B/C):

It can be used to select the mode Hz/%, only applicable for the selection of frequency, AC voltage/ current measurement modes.

#### SELECT button:

it can be used to select range (only applicable for multi-range). Under AC mode, press the button  $\geq 2s$ , display "UFC", enter V.F.C measurement mode and measure the variable frequency voltage. After another  $\geq 2s$  pressing on the button, display "End" and exit the V.F.C measurement mode.

#### HOLD button: (Applicable for full range)

It can be used to lock and hold the displayed value, in such case, LCD displays the prompt " $\overline{)}|$ ", after another press, it is unlocked and enter the normal measurement mode.

The backlight will be illuminated when the time of pressing button is  $\geq 2s$ , after about 15s, the backlight will be automatically turned off; and the backlight will be turned off if pressing the key  $\geq 2s$  when the backlight is illuminated, (Only applicable for UT139A full range: HOLD /LIGHT button)

### IX. Measurement Instruction

Check the built-in AA 1.5Vx2 battery, display will show the symbol "🔋" when lack of power, and then replace battery in time. It is required to pay attention to the symbol "⚠️" beside the test pen socket, which reminds one of the fact that in case of measurement safety, testing voltage or current shall not exceed the specified value

#### 1. AC and DC Voltage Measurement (See Figure 3)

- 1) Connect the instrument with the load in parallel for measurement.
- 2) When the input impedance of the instrument is about  $10M\Omega$ , the load may cause measurement error in the circuit with high impedance. In most cases, the error can be neglected (0.1% or lower) if the circuit impedance is under  $10k$

#### ⚠️ Notes:

- It is forbidden to input voltage higher than 600Vrms, despite of the possibility of measuring higher voltage, as it may damage the instrument.
- It is required to avoid the electric shock in measuring high voltage.

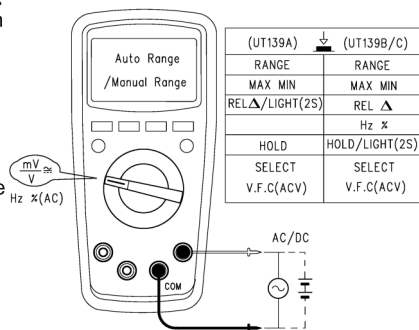

Figure 3

### 2. Resistance Measurement (See Figure 4a)

Connect the instrument with the load in parallel for measurement.

#### ⚠️ Notes:

- \* The display will show "OL" when the measured resistance open-circuit or resistance value exceeds the maximum range of the instrument.
- \* Prior to measuring online resistance, it is necessary to switch off all powers in the circuits to be measured, and release all residual charges to ensure the measurement accuracy.
- \* In measuring low resistance, a measurement error in resistance of about  $0.1\Omega \sim 0.2\Omega$  will be resulted by the test pen. In order to acquire accurate reading, it is required to short circuit the test pen, take REL relative measurement mode to ensure the measurement accuracy.
- \* Check the test pen for any loosening or other reasons in case there is a resistance value no less than  $0.5\Omega$  when test pen is short circuited.
- \* Several seconds may be required for the reading stability when measuring high resistance, which is normal for high resistance measurement.
- \* By using the resistance measurement function, it is allowed to make self-checking of the built-in fuse, see (Figure 4b).
- \* No input higher than DC 60V or AC 30V is allowed.

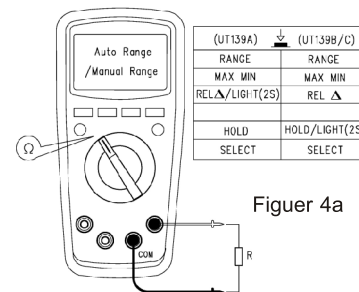

Figure 4a

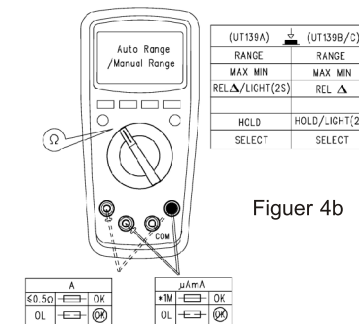

Figure 4b

### 3. Circuit on-off measurement (See Figure 5)

If the resistance of two terminals to be measured is bigger than  $150\ \Omega$ , there will be a circuit break and buzzer will make no sound; if the resistance is  $\leq 10\ \Omega$ , the circuit is deemed with good conductivity and buzzer will continuously sound.

#### ⚠ Notes

- \* Prior to measuring online circuit on-off, it is necessary to switch off all power supplies in the circuits to be measured and release all residual charges to ensure the measurement accuracy.
- \* To prevent personal injury, it is not allowed to input the voltage higher than DC 60V or AC 30V.

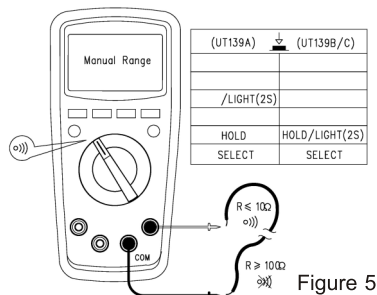

Figure 5

### 4. Diode measurement (Figure 6)

“OL” will be displayed when the diode to be measured is an open circuit or polarity is reversely connected. For Silicon PN junction, the normal value is normally 500~800mV.

#### ⚠ Notes

- \* Prior to measuring online diode, it is necessary to switch off all power supplies in the circuits to be measured and release all residual charges to ensure the measurement accuracy.
- \* Test voltage for diode is about:  
2.1V(UT139A),  
3.2V(UT139B/C).
- \* To prevent personal injury, it is not allowed to input the voltage higher than DC 60V or AC 30V

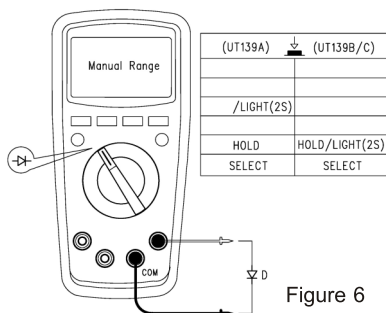

Figure 6

### 5. Capacitance measurement (Only applicable for UT139B/C)

(See Figure 7) The instrument, when without any input, will display a fixed reading which is the internal fixed capacitance value. When measuring small range gear capacitance, the above value shall be subtracted from the value to be measured to ensure the accuracy. The relative measurement REL function can be used to automatically subtract the value to facilitate the measurement.

#### ⚠ Notes

- \* The display will show “OL” when the capacitor to be becomes short-circuited or the capacitance value exceeds the maximum range of the instrument.
- \* Generally, several seconds will be taken to measure high-capacity capacitor.
- \* To prevent damage to the instrument and personal injury, it is required before testing to release all residual charges, which is particularly important for capacitor with high voltage.

### 6. Frequency/Duty Ratio Measurement (Only applicable

(See Figure 8) At the frequency measurement gear, press the button Hz/% to select frequency/duty ratio measurement mode.

#### ⚠ Notes

- \* To prevent personal injury, it is not allowed to input the voltage higher than DC 60V or AC 30V

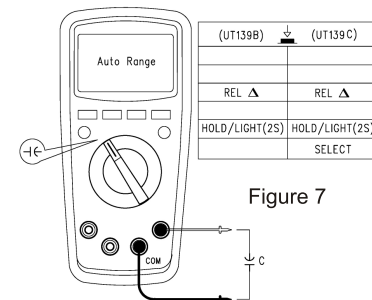

Figure 7

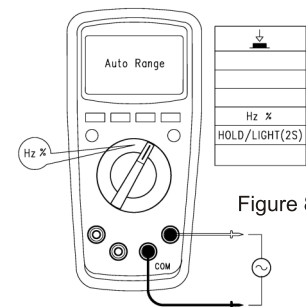

Figure 8



## 7. Temperature measurement (Only applicable for UT139C)

(See Figure 9) Temperature sensor: It is only applicable for K (Ni-Cr and Ni- Si) thermocouple. After startup, "OL" is displayed, complete Celsius or Fahrenheit temperature measurement by connecting the product with K-type temperature sensor.

$^{\circ}\text{F}=1.8^{\circ}\text{C}+32$

### ⚠ Notes

The point type K (Ni-Cr and Ni- Si) thermocouple is only applicable for the measurement of temperature under  $230^{\circ}\text{C}/446^{\circ}\text{F}$ .

## 8. AC and DC current measurement (See Figure 10)

Connect the instrument with the load in serial for measurement. AC measurement value will be true RMS.

### ⚠ Notes

- \*. Before connecting instrument in serial with the loop to be measured, switch off the power supply.
- \*. In measurement, it is required to use proper input terminal and function gear; if unable to estimate the current, the measurement should start with the high gear range.
- \*. Fuses are provided inside the 10A, mA/  $\mu$  input jacks. It is forbidden to connect the table pen test pin in parallel with any circuit, especially the power supply terminal, which may cause damage to the instrument and personal injury.
- \*. For security purposes, when measuring current higher than 5A, the time of each measurement should be controlled less than 10s and an interval of at least 15min should be maintained.
- \*. When measuring AC current online, it is allowed to press the button Hz/% to display online AC frequency/ duty ratio.
- \*. 60A AC and DC current clamp measurement (See Figure 11). Connect as shown in the figure with the attached current clamp.

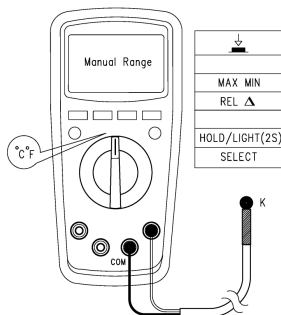

Figure 9

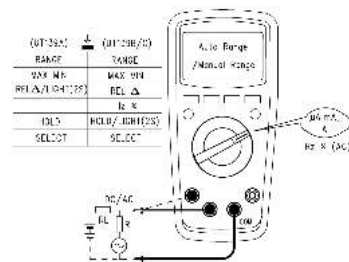

Figure 10

## 9. NCV Non-contact AC voltage sensing (See Figure 12)

If need to detect whether there is a AC voltage or electromagnetic field, allow the front end of the instrument be close to the object to be sensed. The analog quantity of sensed AC voltage is about: "EF" is displayed when  $\leq$  critical voltage.

"EF" is displayed when UT139A > critical voltage, a five-level sound effect (buzzing sound) is generated according to the voltage Vd to mark the difference of sensed voltage.

"-" is displayed when UT139B/C > critical voltage, "-" is designed according to the size of voltage Vd and accompanied by different buzzing sounds to mark the difference of sensed voltage.

By pressing NCV/mV~(only applicable for UT139A), display the analog quantity of sensed mV~ to make the difference of AC voltage.

### ⚠ Notes

Test pen is not required for measurement when the range knob switch is set at "NCV".

## 10. Battery voltage measurement (only applicable for UT139A)

(See Figure 13) The range gear 1.5V is only applicable for the measurement of battery  $\leq 2\text{V}$ , with load resistance of about  $51\Omega$ , while the range gear 9V is only applicable for the measurement of battery  $\leq 15\text{V}$ , with load resistance of about  $1\text{k}\Omega$

- \*. To prevent built-in fuse F1 inside the instrument from burning out due to over-load, it is forbidden to measure the battery or power supply beyond the rated range.
- \*. The measuring time for battery voltage should be as short as possible since there will be built-in analog load power consumption which may shorten the service life of battery.

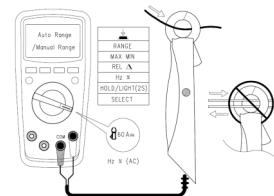

Figure 11

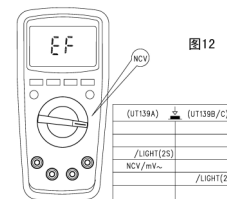

Figure 12

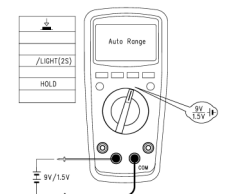

Figure 13

## 11. Other functions:

- \*. After 2s of full display following startup, enter the normal measurement mode. "ErrE" will be displayed in case of any fault to the internal EEPROM.
- \*. Auto power-off: the instrument will be "automatically powered off" to save energy in case of no operation to the knob switch within 15min. Under auto power-off status, any press on the SELECT of UT139A or any button of UT139B/C will "automatically arouse" the instrument, or restart the instrument by turning the knob switch to OFF. Under power-off status, press on SELECT and power on, the buzzer will make five sounds to remind that the auto power-off function has been cancelled. Restarting the instrument after power-off will recover the auto power-off function.
- \*. Buzzer: A "Beep" sound (about 0.25s) from buzzer means the function button is valid when pressing any button or turning the function button. When measuring voltage or current: AC and DC voltage > about 600V mA gear AC/DC current > 190mA(UT139A), 390mA(UT139B), 590mA(UT139C)When A gear AC/DC current is >10A, buzzer will make continuous sounds to remain the over-range. In addition, the buzzer make make 5 continuous sounds about 1min prior to auto power-off and then make one long sound prior to power-off. When the auto power-off function is cancelled, 5 sounds will be made by the buzzer every 15min.
- \*. Low-voltage detection: it is used to detect the internal VDD. When the voltage is lower than 2.4V, the battery under-voltage symbol "" will be displayed, and the normal operation is available; while when lower than 2.2V, no operation is allowed and only the symbol is displayed after startup.
- \*. When the battery supply voltage is reduced to 2.6V, the LCD backlight is weak or can not start; measurement functions can still be used normally.

## X. Technical Index

Accuracy:  $\pm$  (a% reading +b word number), one year of guarantee period.

Ambient temperature:  $23^{\circ}\text{C} \pm 5^{\circ}\text{C}$  ( $73.4^{\circ}\text{F} \pm 9^{\circ}\text{F}$ ) Relative humidity: <75%.

### 1. DC voltage measurement

Range			Resolution	Accuracy
UT139A	UT139B	UT139C		
20.00mV*	40.00mV*	60.00mV*	10 $\mu$ V	$\pm$ (0.5%+2)
200.0mV**	400.0mV**	600.0mV**	0.1mV	
2.000V	4.000V	6.000V	1mV	
20.00V	40.00V	60.00V	10mV	$\pm$ (0.7%+3)
200.0V	400.0V	600.0V	0.1V	
600V	600V	600V	1V	

10M $\Omega$ . (There will be unstable digital display in case of \*/\*\* range open-circuit; after connecting with the load, it can be controlled  $\leq \pm 1$ )

- \* Range: 20mV range for UT139A,  
40mV range for UT139B,  
60mV range for UT139C.
- \* Range: 200mV range for UT139A  
400mV range for UT139B  
600mV range for UT139C.

Maximum input voltage:  $\pm 600\text{V}$

## 2. AC voltage measurement

Range			Accuracy		Resolution
UT139A	UT139B	UT139C	UT139A	UT139B/C	
20.00mV	40.00mV	60.00mV	± (1.0%+3)	± (1.0%+3)	10μV
200.0mV	400.0mV	600.0mV		0.1mV	
2.000V	4.000V	6.000V		1mV	
20.00V	40.00V	60.00V		± (0.8%+3)	10mV
200.0V	400.0V	600.0V		0.1V	
600V	600V	600V	± (1.2%+3)	± (1.0%+3)	1V
V.F.C 200.0V~600V			0.1/1V		± (4.0%+3)

⚠ Input impedance: about 10MΩ.

Display the true RMS. Frequency response: UT139A 45~400Hz, UT139B/C 45~1kHz.(VFC: 45~400Hz)  
Assurance of accuracy:5~100% range, an allowance of <10 words of residual reading for short-circuit.  
It will be up to 3.0 when AC crest factor reaches full value (with except for 600V range, which is up to 1.5 when the range reaches the full value). Maximum input voltage: 600Vrms

## 3. Resistance measurement

Range			Accuracy		Resolution
UT139A	UT139B	UT139C	UT139A	UT139B/C	
200.0Ω*	400.0Ω*	600.0Ω*	± (1.0%+2)	± (1.0%+2)	0.1Ω
2.000kΩ	4.000kΩ	6.000kΩ		1Ω	
20.00kΩ	40.00kΩ	60.00kΩ		± (0.8%+2)	10Ω
200.0kΩ	400.0kΩ	600.0kΩ		100Ω	
2.000MΩ	4.000MΩ	6.000MΩ		± (1.2%+3)	1kΩ
20.00MΩ	40.00MΩ	60.00MΩ	± (1.2%+3)	± (1.5%+5)	10kΩ

⚠ Range: measured value = displayed value – short-circuit value of test pen.

\*. Open-circuit: about \*1V

\*. Overload protection: 600V-PTC

## 4. Circuit on-off, diode measurement

Range	Resolution	Remark
	0.1Ω	Circuit breakage resistance value is set as: >150Ω, buzzer is soundless. Good conductivity is set as: ≤10Ω buzzer sounds.
	1mV	Open circuit voltage is about 2.1V(UT139A), 3.2V(UT139B/C) Normal voltage value of silicon PN junction is about 0.5~0.8V.

⚠ Overload protection: 600V-PTC

## 5. Capacitance Measurement (Only applicable for UT139B/C)

Range	Resolution	Accuracy
9.999nF	1pF	Under REL status: ±(4%+10)
99.99nF~999.9μF	10pF~0.1μF	±(4%+5)
9.999mF~99.99mF	1μF~10μF	±10%(≤2mF)

⚠ Overload protection: 600V-PTC

For capacitor ≤1μF, it is recommended to adopt REL measurement mode to ensure measurement accuracy.

**6. Frequency/duty ratio measurement (only applicable for UT139B/C)**

Range	Resolution	Accuracy
9.999Hz~9.999MHz	0.001Hz~0.001MHz	±(0.1%+4)
1%~99.9%	0.1%	Not defined

⚠ Over-load protection: 600V-PTC

Input range a: (DC level is zero)

≤100kHz:100mVrms≤a≤20Vrms

>100kHz~1MHz : 200mVrms≤a≤20Vrms

>1MHz : 500mVrms≤a≤20Vrms

5MHz~10MHz : 900mVrms≤a≤20Vrms

Duty ratio %: only applicable for measurement ≤100kHz

Remark:

\*. During measurement of AC voltage or AC current, if need to read online frequency value or duty ratio, following input should be met: frequency response: ≤1kHz;

\*. AC voltage: mV range input ≥100mV; V range input ≥ range ×6%

\*. AC current: input range a

4000/6000μA, 400/600mA, 10A range: a≥ range ×6%

400/600μA, 40/60mA, 4/6A range: a≥ range ×60%

**7. Temperature measurement (only applicable for UT139C)**

Range		Resolution	Accuracy
°C	-40~1000°C	1°C	-40~0°C ±3
			>0~100°C ±(1.0%+3)
			>100~1000°C ±(2.0%+3)
°F	-40~1832°F	1°F	-40~32°F ±5
			>32~212°F ±(1.5%+5)
			>212~1832°F ±(2.5%+5)

⚠ Over-load protection: 600V-PTC

Remark: The point type K (Ni-Cr and Ni- Si) thermocouple is only applicable for the measurement of temperature under 230°C/446°F

**8. DC current measurement**

	Range			Accuracy		Resolution
	UT139A	UT139B	UT139C	UT139A	UT139B/C	
μA	200.0μA	400.0μA	600.0μA	±(0.7%+2)	±(0.7%+2)	0.1μA
	2000μA	4000μA	6000μA			1μA
mA	20.00mA	40.00mA	60.00mA			10μA
	200.0mA	400.0mA	600.0mA			0.1mA
A	2.000A	4.000A	6.000A	±(1.0%+3)	±(1.0%+3)	1mA
	10.00A	10.00A	10.00A			10mA

⚠ Over-load protection:

μA mA range:

F1 fuse: (φ6×32)mm FF0.2A H 600V (CE) UT139A FF0.5A H 600V (CE) UT139B FF0.6A H 600V (CE) UT139C

10 A range: F2 fuse: (φ6×25)mm F 10A H 600V (CE)

**9. AC current measurement**

	Range			Resolution	Accuracy
	UT139A	UT139B	UT139C		
μA	200.0μA	400.0μA	600.0μA	0.1μA	±(1.0+3)
	2000μA	4000μA	6000μA	1μA	
	mA	20.00mA	40.00mA	60.00mA	
200.0mA		400.0mA	600.0mA	0.1mA	
A	2.000A	4.000A	6.000A	1mA	±(1.2%+3)
	10.00A	10.00A	10.00A	10mA	

Frequency response: UT139A 45~400Hz, UT139B/C 45~1kHz

Display: true RMS.

Assurance of accuracy: 5~100% range, an allowance of <2 words of residual reading for short-circuit. It will be up to 3.0 when AC crest factor reaches full value.

⚠ Over-load protection: (the same as the DC current over-load protection)

#### 10. (60A) current clamp measurement (only applicable for UT139C)

Range	Resolution	Accuracy
60A dc	0.01A	±(1.0+3)
60A ac		±(1.2+3)

⚠ Over-load protection: 600V-PTC

#### 11. Batter capacity measurement (only applicable for UT139A)

Range	Resolution	Load current	Accuracy
1.500V	1mV	*30mA	±5%
9.00V	10mV	*10mA	

⚠ Over-load protection: F1 fuse: (φ6×32)mm FF0.2A H 600V (CE)

## XI. Upkeep and Maintenance

⚠ Warning: Power shall be switched off before opening the rear cover of the instrument; and the test pen shall be away from the input terminal and circuit to be measured.

### 1. Conventional upkeep and maintenance

- \* For upkeep and maintenance, wet cloth and mild cleanser rather than abrasive or solution shall be used to clean the meter housing.
- \* Please stop using and send for maintenance in case of any abnormal condition about the instrument.
- \* The inspection or maintenance for instrument, if necessary, shall be performed by the qualified professional maintenance personnel or designated maintenance department.

### 2. Battery or fuse tube replacement (See Figure 14)

Built-in battery shall be replaced in time when LCD displays the under-voltage prompt "  ", otherwise measurement accuracy may be affected.

Battery specification: AA 1.5Vx2

#### Operating steps:

1. Set the power switch at "Off", take the test pen away from the input jack and remove the protective sleeve.
2. Screw off one screw securing batter rear cover with screw driver, remove the cover and replace:  
The under-voltage used battery and burnout fuse:  
F1 fuse: (φ6×32) mm FF0.2A H 600V (CE)(UT139A)  
FF0.5A H 600V (CE)(UT139B)  
FF0.6A H 600V (CE) (UT139C)
3. Screw off the second screw securing the rear cover with screw driver and remove the cover to replace the burnout F2 fuse (φ6×25) mm F 10A H 600V (CE).

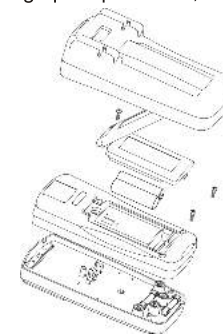

Figure 14

**UNI-T**

UT139A/B/C OPERATING MANUAL

**UNI-T**

UT139A/B/C OPERATING MANUAL

The User Manual is subject to modification without further notice.

**UNI-T**<sup>®</sup>

**UNI-TREND TECHNOLOGY (CHINA) CO., LTD.**

No6, Gong Ye Bei 1st Road,  
Songshan Lake National High-Tech Industrial  
Development Zone, Dongguan City,  
Guangdong Province, China  
Tel: (86-769) 8572 3888  
<http://www.uni-trend.com>