

# OPERATING & USERS MANUAL

## MANUEL D'INSTALLATION ET D'UTILISATION

### PROLITE Series

Automatic IP65  
battery chargers

### Série PROLITE

Chargeurs IP65 de batteries

12V15A

12V25A

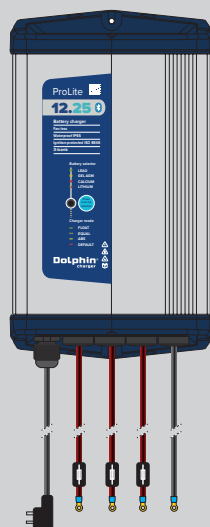
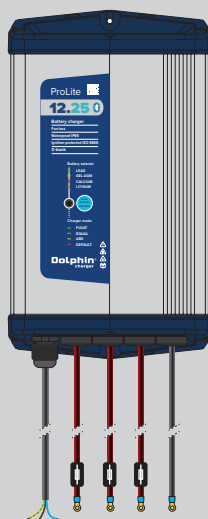
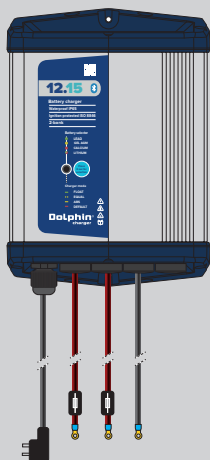
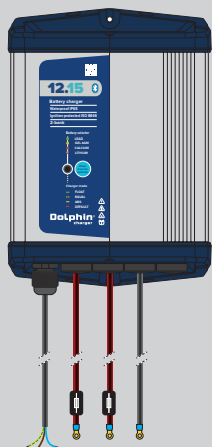

230V

115V

115V / 230V

(Nema 5-15)

(Nema 5-15)

Code 399710

Code 399715

Code 399720

Code 399725

**Dolphin**<sup>®</sup>  
charger

# Summary

GENERAL SAFETY INSTRUCTIONS	2
<b>SAFETY INSTRUCTIONS</b>	2
Installation	2
Connections	3
Serial number	4
Choosing the charging curve	4
Maintenance	4
Safety battery instructions	4
Exposure to chemicals and gases hazard	5
PRODUCT OVERVIEW	5
LOCATION OF INSTALLATION	6
Installation	6
CONNECTIONS	7
Overview	7
AC Power wiring US version	8
AC Power wiring Standard version	8
DC Power wiring	8
Typical wiring with one battery	9
Typical wiring with two batteries	10
Typical wiring with three batteries	11
OPERATING INSTRUCTIONS	12
<b>Dolphin Connect</b> App	14
Selecting a charging profile from the app	15
Charger's front display	17
TECHNICAL SPECIFICATIONS	18
DIMENSIONS	19
ProLite 12V15A - 230 V	19
ProLite 12V15A - 115 V - Nema 5-15 plug	20
ProLite 12V25A	21
ProLite 12V25A - Nema 5-15 plug	22
TROUBLESHOOTING	23
Replacing in-line DC fuse	23
Others issues	23
WARRANTY	23
Disposal	24
CE conformity	24
ISO 8846 Ignition Protected / SAE J1171:2016 certified	25
FCC conformity	25

# GENERAL SAFETY INSTRUCTIONS

This manual contains vital and essential information, in order to avoid electrical shocks, overcharging or irreversible damage to the material. The owner should read and understand this document before operating the charger.

**This device is not intended for use by persons (including children) with physical, sensory or mental disability, or by persons lacking experience or knowledge, unless they have received from a person in charge of their safety adequate supervision or preliminary instructions on how to use the device.**

For any question, contact your dealer.

## SAFETY INSTRUCTIONS

Those symbols indicate a danger, the different degrees of which are described below.

### ATTENTION

Indicates a danger which may result in damage to or destruction of the product.

### PRECAUTION

Indicates a danger which may result in minor or moderate injury.

### WARNING

Indicates a danger which may result in death or serious injury.

### DANGER

Indicates a danger which may result in immediate death or serious injury.

## Installation

### ATTENTION

- Do not expose the battery charger to rain, snow or bilge water.
- Do not operate the battery charger if it has received a sharp blow, been dropped, has cracks or openings in the enclosure, or is otherwise damaged in any other way.
- Do not install the charger near a heat source.
- It should not be installed in an airtight or badly ventilated area.

**PRECAUTION**

- Do not disassemble the battery charger. There are no user-serviceable parts with the exception of a user-replaceable fuse at the DC output wiring compartment.
- Do not operate the battery charger with damaged or substandard wiring.
- In order to maintain watertightness, it is strictly forbidden to dismantle the charger and/or to modify the casing and/or wirings in any way.

This charger is suitable for use in marine engine compartments, and near fuel tanks.

Leave at least 10cm / 3inches clearance around the charger for proper ventilation.

Install the charger in a vertical position to create an optimal ventilation. Note that wirings are at the bottom of the charger.

All electrical connections to and from the charger must remain accessible all the time.

The charger must be correctly and strongly fixed.

This device is not a toy and must be kept out of the reach of children.

**Connections****ATTENTION**

- To prevent overheating, ensure the correct tightening of the connections.

**WARNING**

- In order to protect the occupants, the main power supply access must be attached to a differential circuit breaker (refer with technical specifications).
- For safety reason, the green / yellow wire of the power cord must strictly be connected to the earth of the installation.
- Each access connected to the battery is protected with a sealed fuse integrated with the wire. Do not remove or change those fuses.

According to the model, the charger is set to be connected to a monophase network 230V – 50/60 Hz or 115V - 50/60 Hz (refer with technical specifications).

The installation to which the charger is connected must comply with the standards currently enforced in the country of use.

**European Version: the cable N°1 of power cord must be connected to the LINE or PHASE, the N°2 to the NEUTRAL.**

**US Version: The battery charger is supplied with an extension cord. Connect it at the nearby 120 VAC GFCI (Ground Fault Circuit Interrupt) outlet.**

**US Version:** External connections to the battery charger shall comply with the United States Coast Guard electrical regulations (33CFR183, Sub Part 1).

Output batteries must be connected to the charger before its power-on.

This device complies with enforced standards regarding emitted interferences and disturbances of external origin.

Regarding electromagnetic interferences, ensure that other materials used are compatible with this device in order to avoid irreversible damage.

## Serial number

The S/N is available on the grey sticker on the top side of the charger.

## Choosing the charging curve



### WARNING

- It is important to choose the correct charging curve, appropriate with the battery technology. An incorrect choice can cause irreversible damage. In particular, risk of overheating and noxious gases in case of overvoltage to the battery.

The LITHIUM cycle charge is only compatible with LiFePo4 batteries with integrated BMS (Battery Management System).

## Maintenance

If necessary, fuses on positive access must be replaced with identical products.

This charger cannot be dismantled and thus, the electronic power board is inaccessible. **Except fuses, therefore, any maintenance on site is prohibited.**

## Safety battery instructions



### DANGER

- Disconnect both AC and DC power from the battery charger before attempting and maintenance or cleaning or working on any circuits connected to the battery charger.
- When disconnected make sure battery terminals are fully insulated.

## Exposure to chemicals and gases hazard

### ATTENTION

- Make sure the area around the battery is well ventilated. Gas produced by batteries can be explosive. Protect eyes when around batteries. Provide adequate ventilation so hydrogen gas accumulation does not exceed 2% by volume. Do not smoke, use open flame or create spark near batteries at any time.
- Make sure the voltage of the batteries matches the output voltage of the battery charger.
- Be careful to keep corrosion from coming into contact with your eyes and skin when cleaning battery terminals. Always remove metal objects from hands, wrists & neck e.g. rings, bracelets, watches & necklaces.
- Always work with the battery ungrounded. Battery ground connections, if required, should be made last.

## PRODUCT OVERVIEW

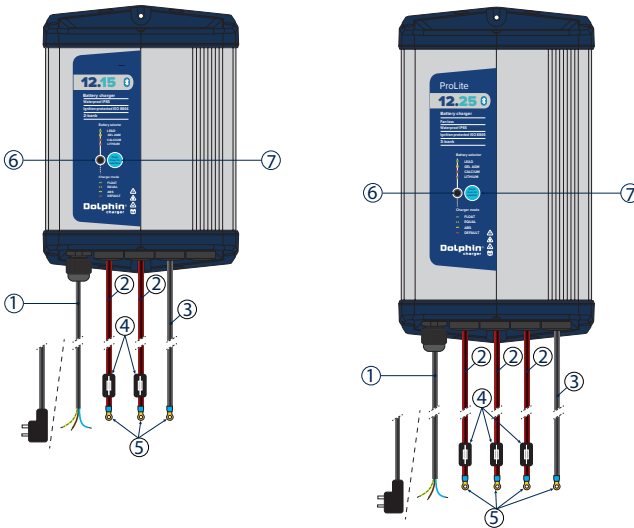





①	AC Cord
②	Positive battery connection
③	Negative battery connection
④	Fuse
⑤	Battery connection terminal
⑥	LED
⑦	Setting push-button

## LOCATION OF INSTALLATION

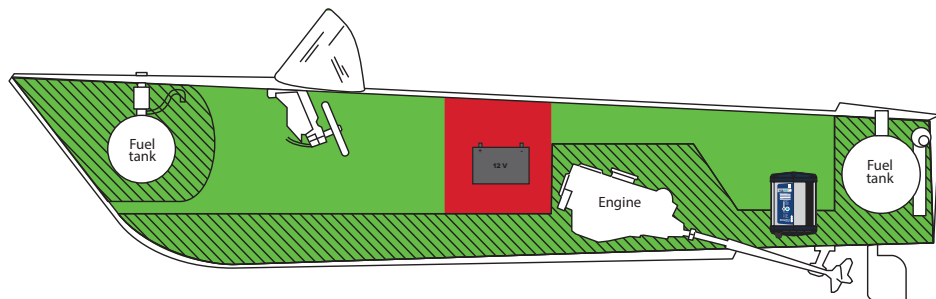
Never place charger above battery being charged. Gases from battery will corrode and damage charger.

The unit is ignition protected: ProLite chargers can be installed in spaces containing gasoline powered machinery, or gasoline fuel tank(s), or other connection(s) between components of a gasoline system.



-  Equipment protected against ignition of flammable gases
-  Possible areas for installing the Prolite charger
-  Prohibited area for installation of the Prolite charger

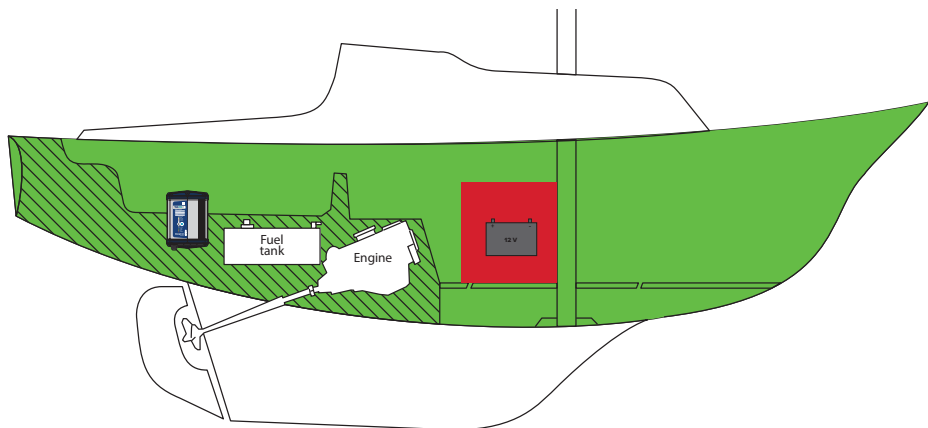

## Installation

All ProLite chargers are designed to be permanently mounted on-board and should be mounted with cables down. More details «TECHNICAL SPECIFICATIONS», page 18.

# CONNECTIONS

ProLite chargers are supplied with three (25Amp) or two (15Amp) positive DC cables including ring battery terminals and waterproof fuseholder and one negative DC cable including ring battery terminal. Each DC cable has a length of 1,8 meter (6 feet) DC terminals are supplied with ring battery terminal 8,5mm diameter for 8mm battery stud.

## Overview

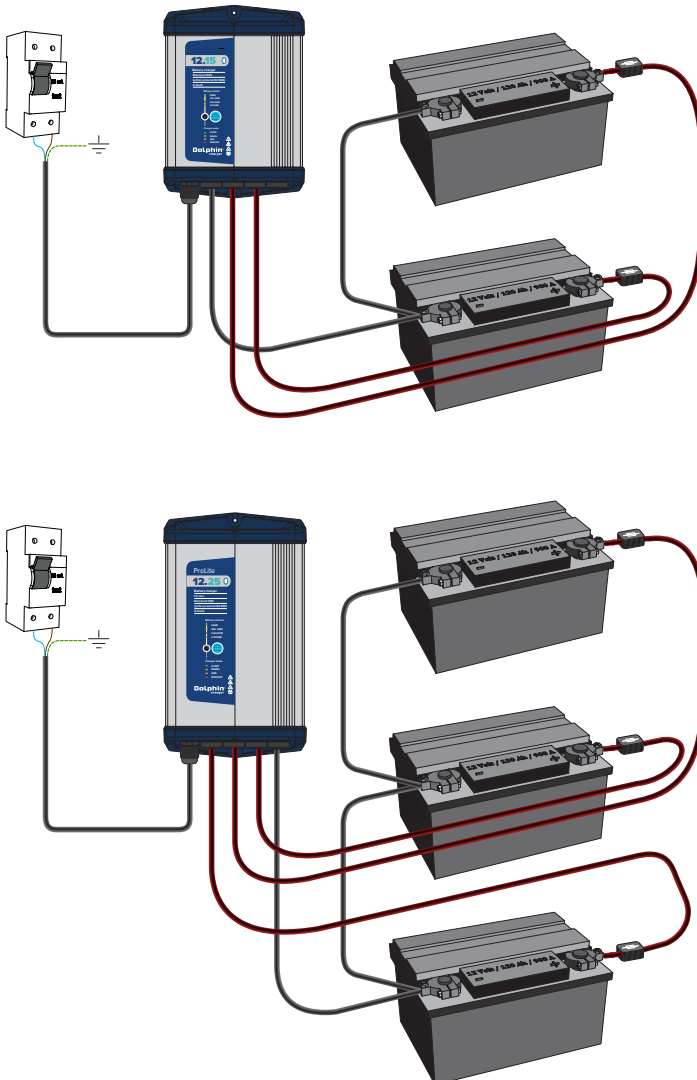



## AC Power wiring US version

US Version: The battery charger is supplied with an extension cord. Connect it at the nearby 120 VAC GFCI (Ground Fault Circuit Interrupt) outlet.

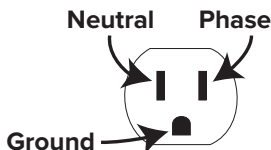

## AC Power wiring Standard version

ProLite chargers Standard version are supplied with a 1,8 meter 3 wire 0,75mm<sup>2</sup> each stripped ends cable. AC cable must be wired to RCCB 30 mA CB. Ground wire must be connected.

## DC Power wiring

### DANGER

- Disconnect AC power from your charger before any DC wiring

The following wiring diagram are for main AC to RCCB. DC wiring will be the same for both standard and US models supplied with NEMA 15-5 plug.

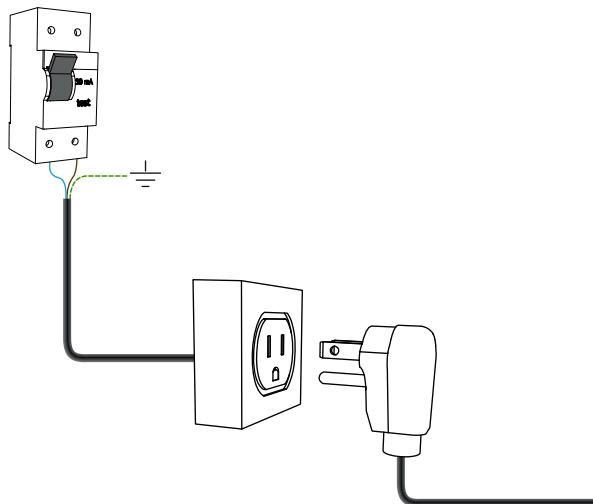

## Typical wiring with one battery

When only one battery is connected other two DC positive cable terminals must be isolated in waterproof boxes or either remove their in-line fuses.

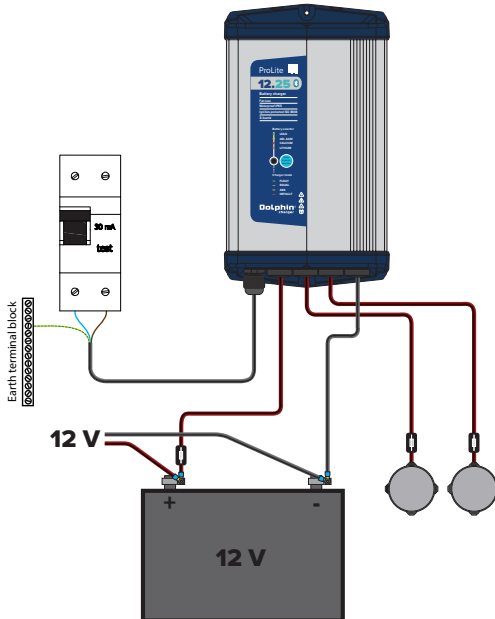
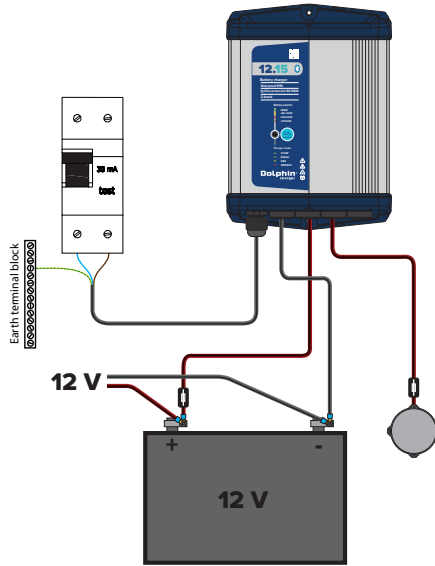

## Typical wiring with two batteries

When only two batteries are connected other third DC positive cable terminals must be isolated in waterproof boxes or either remove their in-line fuses.

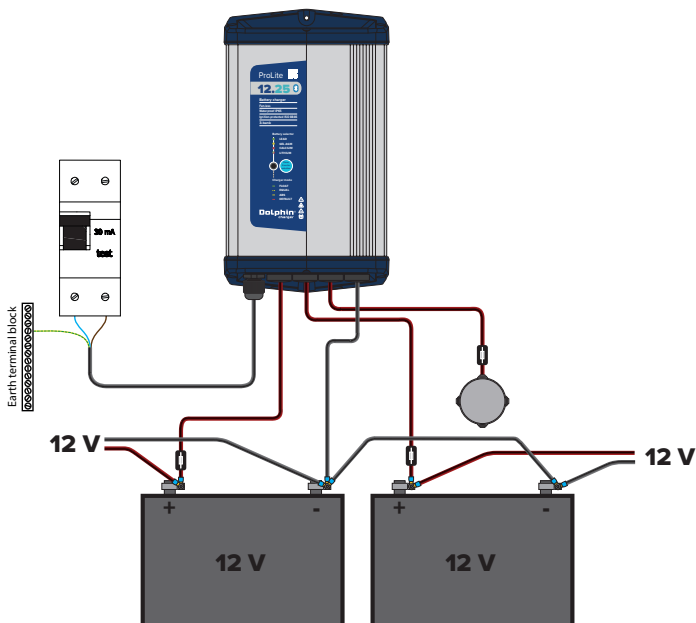
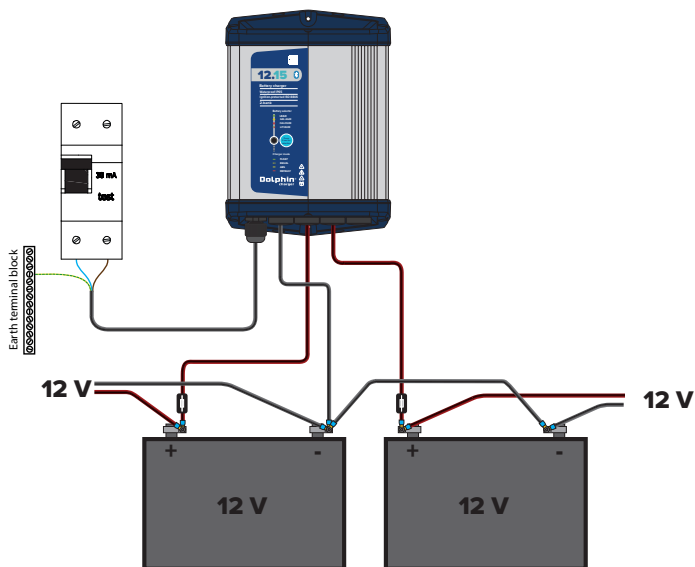

# Typical wiring with three batteries

## Three battery banks

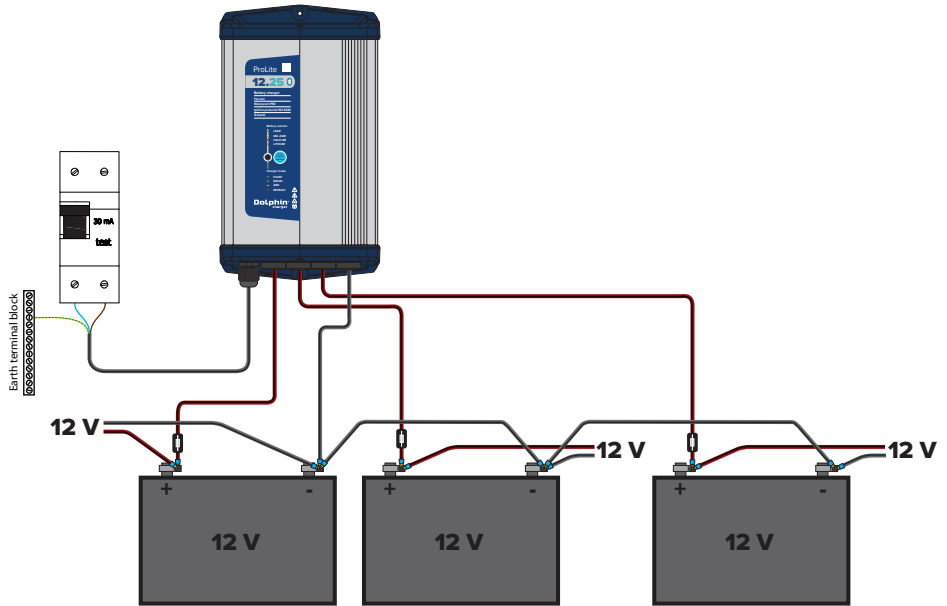

# OPERATING INSTRUCTIONS

The ProLite charger is design to charge battery of the same type. Do not mix battery type.

## ATTENTION

It is important to select the correct charging profile for your battery. If you are still unsure what kind of battery you have we recommend that you contact the manufacturer of the battery.

### Selecting a charging profile



1. Power-on the charger connected to the batteries.

**Note that during the power-on of the charger, the LED indicates for a few seconds the current cycle charge (refer to below color vs cycle).**

2. Wait a few seconds and verify that the charger is correctly charging the batteries (NORMAL mode).
3. If necessary, press the push-button for 3 secondes : the charger enters the SETTING mode, and the LED is blinking.
4. Press down the push-button the number of times equal to the selected charging profile using the LED colour code.

Led	Type de batterie
Green	Open Lead
Yellow	AGM - Gel
Red	Lead Calcium
Green / red	Lithium

5. After your choice, wait a few seconds, the charger returns automatically in NORMAL mode.

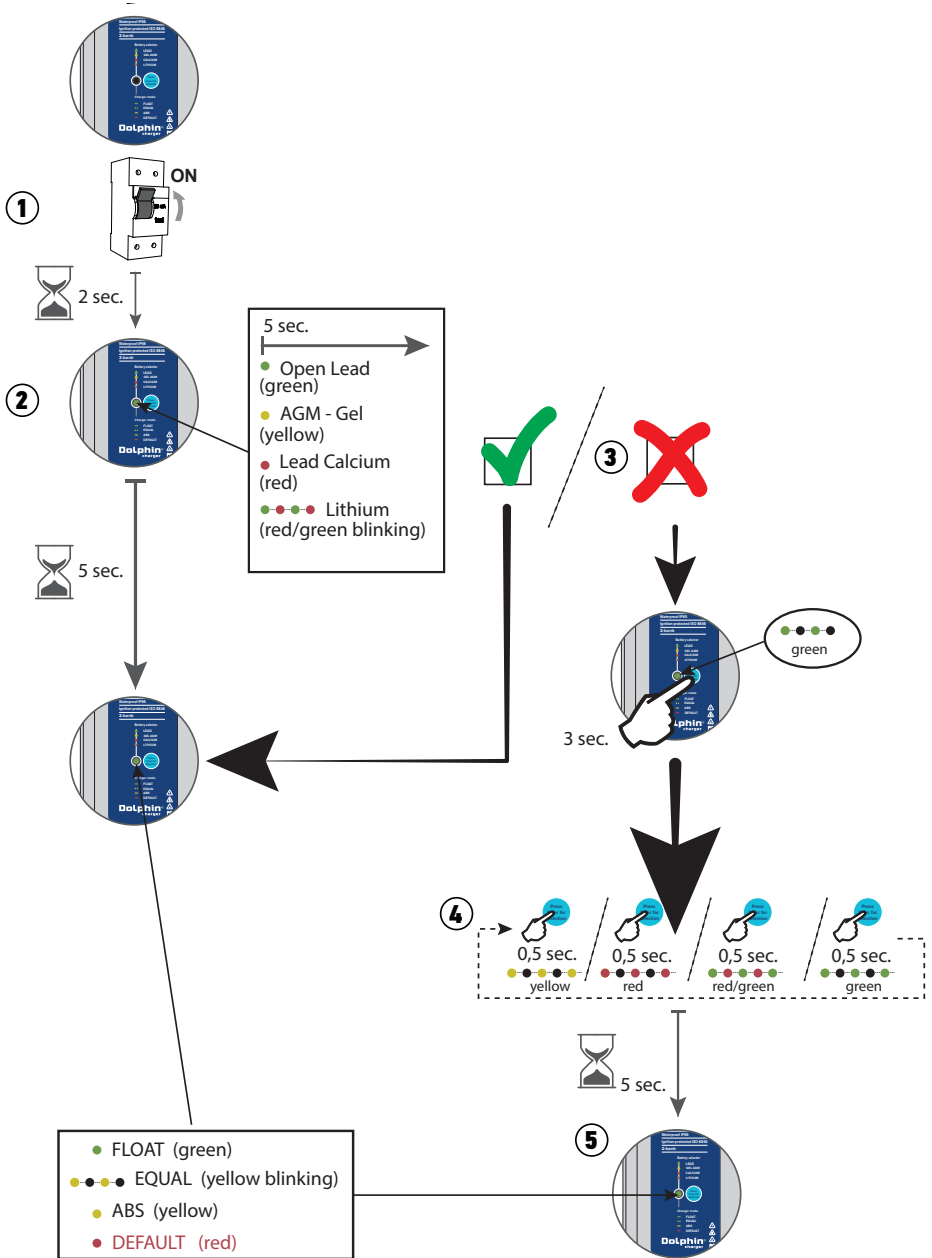

6. Preventively, verify the output charge voltage (Boost & Float phases).

Mode	Open Lead	AGM – Gel	Lead Calcium	Lithium
<b>ABS mode</b>	14,5V	14,5V	15V	14,5V
<b>EQUAL mode</b>	-	-	-	-
<b>End of EQUAL mode</b>	-	-	-	-
<b>FLOAT mode</b>	13,4V	13,6V	13,8V	14,5V

Example of load curve :

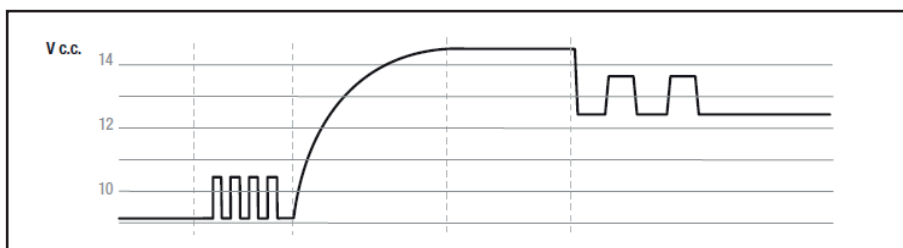

## Dolphin Connect App

The smartphone App DolphinConnect dashboard allows you to monitor in real time your ProLite charger.

The network range can be up to 10 meters (30 feet) depending the environment





In order to pair the ProLite charger and your device (smartphone or tablet) you need to enter the PIN number. PIN number is available on product label.

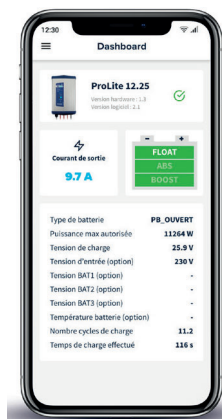

Note: The product label is also available on the packaging of the ProLite charger.



## Selecting a charging profile from the app

<p>After installing the app click on icon to launch it.</p>	
<p>Click on the home page to launch the app.</p>	
<p>Make sure Bluetooth is turned on. Make sure ProLite charger is on. Click on «detect my product».</p> <p>Note: if Bluetooth is turned off the following window will appear:</p>	
<p>If ProLite charger is detected it will appear in this window. Click on the screen for validation.</p>	



Enter the PIN number available on product label.

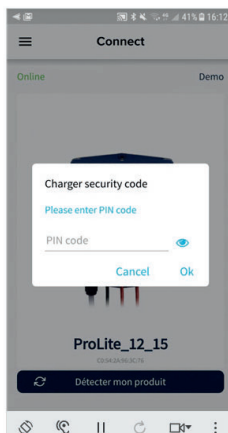

The screen will display the state of charger and actual charging stage.



Left to right screen or click on menu button ≡ to navigate. In order to change charging profile click on «configuration».

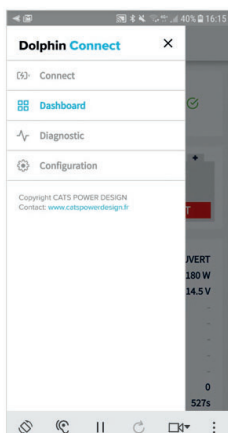

It is important to select the correct charging profile for your battery. If you are still unsure what kind of battery you have we recommend that you contact the manufacturer of the battery.

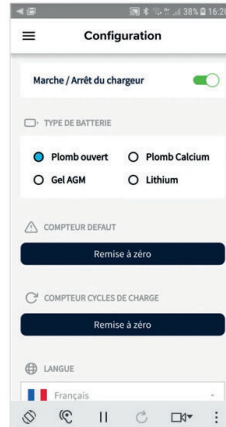

## Charger's front display

Mode	LED	Status
<b>ABS mode</b>	Yellow	Batteries are charging. Time required to complete "Absorption" depends on the initial SOC of the batteries, but it is limited to 8hrs
<b>EQUAL mode</b>	Yellow blinking	Batteries are coming to the end of the cycle charge. Time required to complete "Equalization" depends on the initial SOC of the batteries and varies between 30mn to 4hrs
<b>End of EQUAL mode</b>	Green blinking	Batteries are almost charged. Floating mode will begin in less than 30mn
<b>FLOAT mode</b>	Green	Batteries are completely charged
<b>OT default</b> (Over Temperature)	Red slow blinking	Charger is stopped for a period of 30sec min. The restart is automatic once the defect has disappeared. → Check the external ambient temperature.
<b>RP default</b> (Reverse Polarity)	Green / red blinking	Charger is stopped for a period of 30sec. The restart is automatic once the defect has disappeared. → Check all connections and the polarity of the batteries. → Note that the internal battery fuse cannot be replaced.
<b>OVO default</b> (Output Over Voltage)	Red fast blinking	Charger is stopped for a period of 30sec. The restart is automatic once the defect has disappeared. → Check the output voltage. In general, this default is irreversible.

# TECHNICAL SPECIFICATIONS

	12V/15A	12V/25A
<b>Input</b>		
<b>Voltage</b>	115V or 230V (+/-10%) selon modèle	115/230V (+/-10%)
<b>Frequency</b>	50/60 hz (+/-10%)	
<b>Cos phi</b>	> 0,5	> 0,9
<b>Efficiency</b>	> 90%	
<b>Max Current</b>	4A or 2A According to model	4A/2A
<b>Output</b>		
<b>Qty of output</b>	2	3
<b>Qty of cycles charge</b>	4 (3 stages I.Uo.U)	
<b>Boost / Float</b>	Open Lead AGM – Gel Lead Calcium Lithium	14,5V / 13,4V 14,5V / 13,6V 15,0V / 13,8V 14,5V
<b>Voltage precision</b>	+/-2%	
<b>Max Power / Current</b>	15A / 180W	25A / 300W
<b>Ripple</b>	< 1% (BW < 20MHz)	
<b>Protections</b>		
<b>Electronic</b>	Output short circuit / Output over voltage Output reverse polarity / Over temperature	
<b>Internal fuses</b>	General protection (irreversible damage)	
<b>External +BAT fuses</b>	F20A	F30A
<b>General</b>		
<b>Display</b>	Front tri-color LED	
<b>Control</b>	Front push-button or via "Dolphin Connect App"	
<b>Operating t°</b>	-10°C to +55°C (automatic derating)	
<b>Storage t°</b>	-20°C to +70°C	
<b>Humidity</b>	10% to 90%	
<b>IP</b>	IP65	
<b>Ventilation</b>	Natural convection	
<b>Safety</b>	EN60335-1, EN60335-2-29, ISO8846, SAEJ1171, UL1236	
<b>EMC</b>	EN 55014-1, EN55014-2	
<b>Casing</b>	Anodized extruded aluminium	
<b>Mounting</b>	Wall-mounting 2 x M4 Screws	
<b>Dimensions</b>	142 x 72 x 194 mm 5.51 x 2.76 x 7.68"	140 x 70 x 245 mm 5.51 x 2.76 x 9.65"
<b>Weight</b>	1,4 Kg / 3.1 lbs	1,7 Kg / 3.8 lbs
<b>Wires length</b>	1,8 m / 5,9 feet	
<b>AC access</b>	3 x 0,75mm <sup>2</sup> With NEMA 15-5 plug for 399715 and 399725 models	
<b>DC access</b>	AWG12 (399715 and 399710 models) or 14 (399725 and 399720 models) with ring terminal diameter 8,5mm for 8mm battery stud	

# DIMENSIONS

## ProLite 12V15A - 230 V

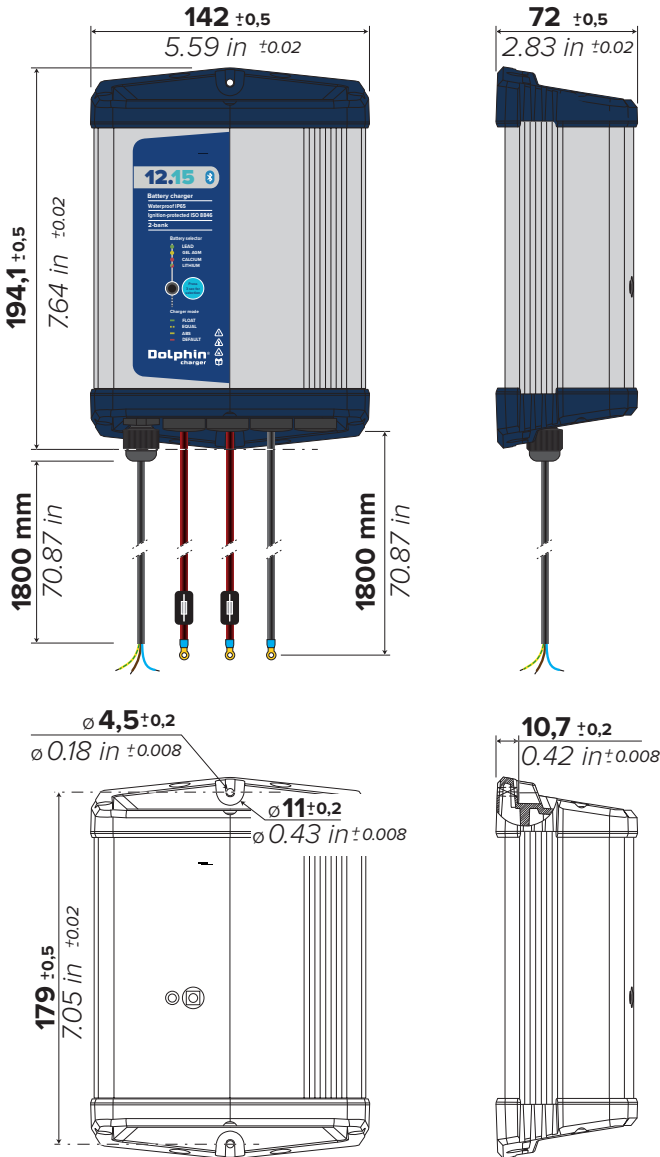

# ProLite 12V15A - 115 V - Nema 5-15 plug

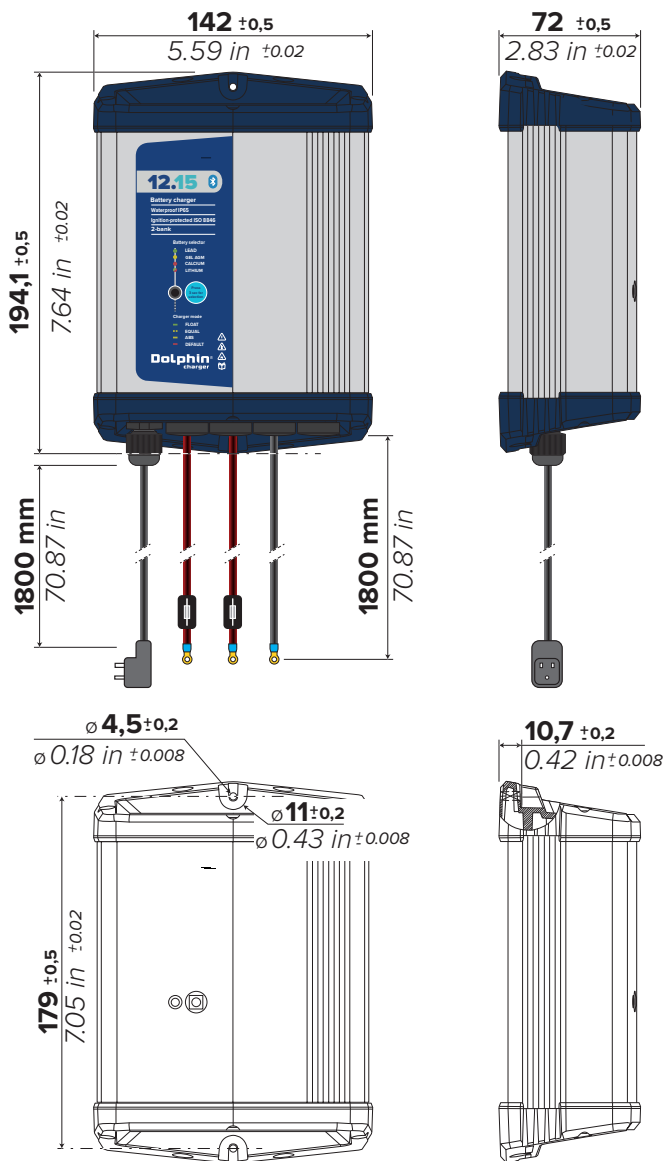

**ProLite 12V25A**

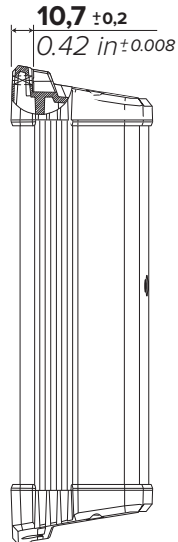
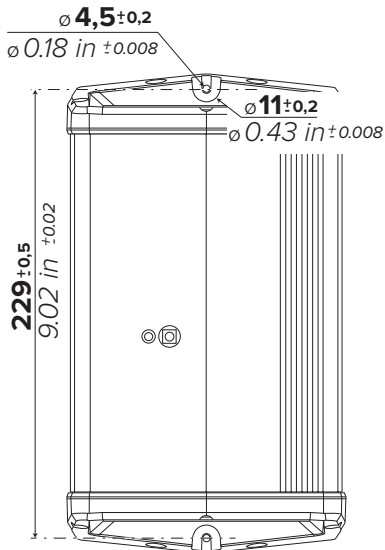
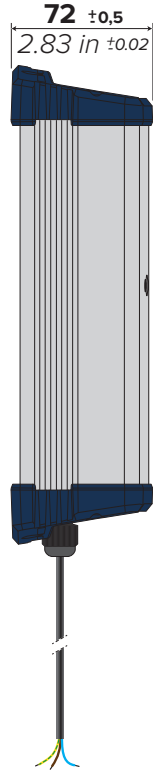
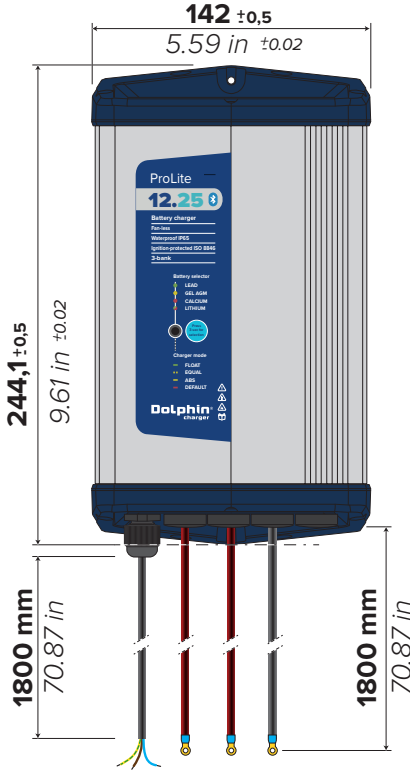

## ProLite 12V25A - Nema 5-15 plug

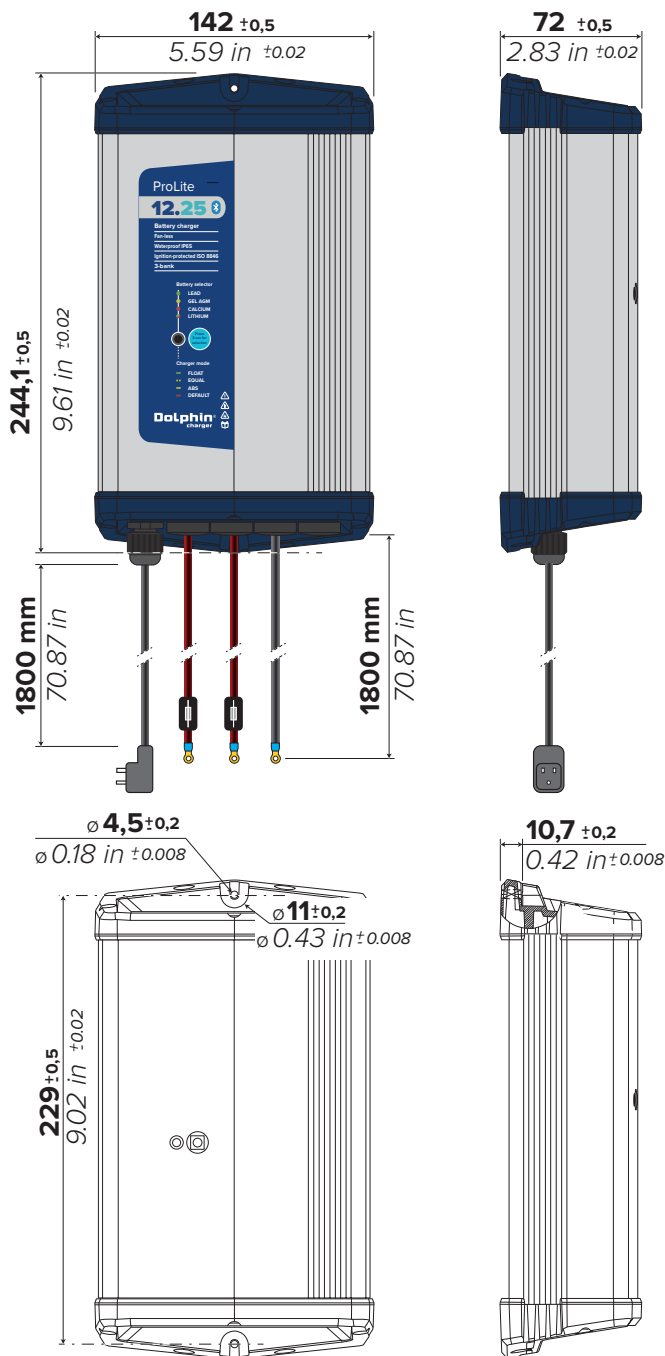

# TROUBLESHOOTING

## Replacing in-line DC fuse

### ATTENTION

Before replacing a fuse it is important to check the origin of fault.

To replace DC fuses please follow the instructions:

- Disconnect AC Power from the electrical outlet.
- Disconnect DC negative cable.
- Disconnect AD positive cable to be replaced.
- Open the waterproof fuse holder.
- Check the fuse with the ohmmeter of a multimeter.
- If fuse is blown replace it using the same amperage.
- Closed the waterproof fuse holder.
- Connect DC positive cable.
- Connect DC negative cable.
- Connect AC power .
- Check the normal operation of the installation.

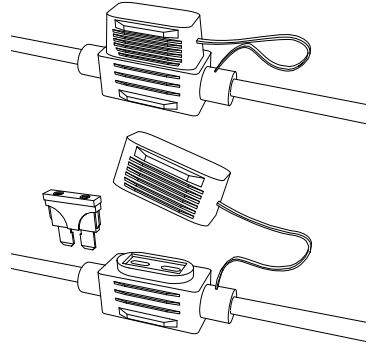

## Others issues

Check Fault alarms status and contact reseller or factory if needed.

## WARRANTY

In order to prevent all risks due to the incorrect use of the device, please read carefully the list of possible situations or faults not covered by the warranty.

- Disassembly and/or modification of the casing resulting into the loss of the watertightness and/or the damage of the charger.
- Disassembly and/or modification of the electronic power board resulting into the malfunction or the damage of the charger.
- Mechanical shocks on the casing resulting into the loss of the watertightness and/or the damage of the charger.
- Use of a non-appropriate main power supply (for example a generator with a too high voltage) resulting into the malfunction or the damage of the charger.
- Over-voltage from the main or a lightning strike.
- Battery in reverse polarity but connected “in live” to a charger in operation, resulting into a damage of the charger.
- Obvious connections errors resulting into the malfunction or the damage of the charger.



- Wires modified, fuses removed or replaced with non-appropriate products.
- Water to the interior of the device resulting the malfunction or the damage of the charger.
- Cycle charge non appropriate with the technology of the battery, in particular when the charge voltage is too high, risk of overheating and noxious gases.
- Use with LITHIUM batteries without integrated BMS.

## Disposal



This device contains electronic and mechanical components that must be recycled once the device is obsolete.

All electronic devices must be returned to a local distributor or to a specialized company for an environmentally friendly disposal.

## CE conformity



This product conforms to current European standards and has a CE mark. Please contact us for the certificate of conformity.

### DECLARATION OF CONFORMITY CE

Manufacturer: **CATS POWER DESIGN**

Address: 144 route des Vernes  
74370 Pringy  
France

I, undersigned Alain Pontille (CEO), declare that the products identified below:

399725- BATT. CHARG. DOLPHIN PROLITE 12V25A  
399715- BATT. CHARG. DOLPHIN PROLITE 12V15A

399720- BATT. CHARG. DOLPHIN PROLITE 12V25A  
399710- BATT. CHARG. DOLPHIN PROLITE 12V15A

Comply with the following directives:

REACH directive EC 1907/2006.

ROHS directive 2011/65/EU.

EMC directive 2014/30/EU.

Standards applied:

- EN/IEC 61000-6-1
- EN/IEC 61000-6-3

LVD directive 2014/35/EU.

Standards applied:

- EN/IEC 60335-1
- EN/IEC 60335-2-29

A. Pontille

## ISO 8846 Ignition Protected / SAE J1171:2016 certified



515 Gus Hipp Blvd.  
Rockledge, Florida 32955  
Telephone (321) 632-2008  
www.imanna.com

Post Office Box 560933  
Rockledge, Florida 32956-0933  
FAX (321) 690-3360  
E-mail: info@imanna.com

June 14<sup>th</sup>, 2019

Cats Power Design  
144, route des Vernes  
74370 Pringy - France

To Whom It May Concern:

IMANNA Laboratory tested samples of the ProLite 12.25 and ProLite 12.15 battery chargers for ignition protection. These tests were conducted in accordance with SAE J1171:2017 and ISO 8846:2016. The results of these tests are covered under IMANNA Reports 21317-1 and 21359-1 for the ProLite 12.25 and ProLite 12.15, respectively. The results indicate that both chargers comply with the requirements stated in SAE J1171:2017 and ISO 8846:2016 and are certified as ignition protected.

Sincerely,

Robert L. White, Pres.

## FCC conformity

Designed and tested comply to UL STD 1236

Designed and tested comply to CSA STD C22.2 No 107.2

Designed and built to ABYC A-31 standards



# **Dolphin<sup>®</sup>** **charger**



**Dolphin Charger**  
2, Chemin de Branchy  
74600 ANNECY  
France  
contact@dolphin-charger.com  
<https://www.dolphin-charger.com>