

RM85

miniature relays

RM85







RM85-...-01 (AC) ①



RM85-...-01 (DC) ①



- Relays designed for continuous operation*
- CTI 250 • Reinforced insulation • For PCB and plug-in sockets • AC and DC coils, insulation class F: 155 °C
- Available special versions: in transparent cover ①; with the increased dielectric strength of the contact clearance ② • Compliance with standards EN 60335-1, EN 45545-2 • Recognitions, certifications, directives: RoHS,     

Contact data

Number and type of contacts	1 CO, 1 NO ②
Contact material	AgNi , AgNi/Au hard gold plating, AgSnO ₂
Rated / max. switching voltage	AC 250 V / 400 V
Min. switching voltage	5 V AgNi, 5 V AgNi/Au hard gold plating, 10 V AgSnO ₂
Rated load (capacity)	AC1 16 A / 250 V AC AC15 3 A / 120 V 1,5 A / 240 V (B300) DC1 16 A / 24 V DC (see Fig. 3) DC13 0,22 A / 120 V 0,1 A / 250 V (R300)
Motor load	acc. to UL 508 1/2 HP 240 V AC, 4,9 FLA, single-phase motor ③ AC3 acc. to IEC 60947-4-1 0,5 kW 240 V AC, single-phase motor
Min. switching current	5 mA AgNi, 2 mA AgNi/Au hard gold plating, 10 mA AgSnO ₂
Max. make current	30 A AgSnO ₂
Rated current	16 A
Max. breaking capacity	AC1 4 000 VA
Min. breaking capacity	0,3 W AgNi, 0,05 W AgNi/Au hard gold plating, 1 W AgSnO ₂
Contact resistance	≤ 100 mΩ
Max. operating frequency	• at rated load AC1 600 cycles/hour • no load 72 000 cycles/hour

Coil data

Rated voltage	50/60 Hz AC 12, 24 , 48, 60, 110, 115, 120, 220, 230 , 240 V DC 3, 5, 6, 9, 12 , 18, 24 , 36, 48, 60, 110 V
Must release voltage	AC: ≥ 0,15 U _n DC: ≥ 0,1 U _n
Operating range of supply voltage	see Tables 1, 2 and Fig. 4, 5
Rated power consumption	AC: 0,75 VA DC: 0,4 W

Insulation according to EN 60664-1

Insulation rated voltage	400 V AC
Rated surge voltage	4 000 V 1,2 / 50 μs
Overvoltage category	III
Insulation pollution degree	3 250 V 2 400 V
Flammability class	V-0 for standard cover (no transparent), UL 94
Dielectric strength	• between coil and contacts 5 000 V AC type of insulation: reinforced • contact clearance 1 000 V AC type of clearance: micro-disconnection 2 000 V AC contact 1 NO, type of clearance: full-disconnection ②
Contact - coil distance	clearance: ≥ 10 mm creepage: ≥ 10 mm

General data

Operating / release time (typical values)	AC: 7 ms / 10 ms DC: 7 ms / 3 ms
Electrical life	• resistive AC1 > 0,7 x 10 ⁵ 16 A, 250 V AC (number of cycles) > 10 ⁴ 20 A, 250 V AC, 85 °C (RM85-3021-25-1...) • motor load acc. to UL 508 10 ⁵ 5 FLA / 7 LRA, 240 V AC, 65 °C (RM85-3021-5-1...) 10 ⁵ 5 FLA / 12 LRA, 24 V DC, 65 °C (RM85-3021-5-1...) 3 x 10 ⁴ 5 FLA / 30 LRA, 240 V AC, 70 °C (RM85-2021-5-1...) • cosφ see Fig. 2 • DC L/R=40 ms > 10 ⁵ 0,15 A, 220 V DC
Mechanical life (cycles)	> 3 x 10 ⁷
Dimensions (L x W x H) / Weight	29 x 12,7 x 15,7 mm / 14 g
Ambient temperature	• storage -40...+85 °C (non-condensation and/or icing) • operating coil AC: -40...+70 °C coil DC: -40...+85 °C -20...+70 °C ①
Cover protection category	IP 40 ① or IP 67 EN 60529
Environmental protection	RTII ① or RTIII EN 61810-1
Shock resistance	20 g
Vibration resistance	(NO/NC) 10 g / 5 g 10...150 Hz
Solder bath temperature / Soldering time	max. 270 °C / max. 5 s

The data in bold type relate to the standard versions of the relays. *The relays are designed for continuous operation while maintaining the parameters declared in the data sheet. ① Special versions - relays in transparent cover (certifications cULus, EAC), only available with IP 40 and RTII, operating temperature -20...+70 °C. See "Ordering codes". ② Special versions - relays with one normally open contact 1 NO, with increased contact gap - dielectric strength 2000 V AC, only available with DC coils. See "Ordering codes". ③ For single phase motors for 110-120 V AC do not use motors with higher FLA than given for 240 V AC.

RM85

miniature relays

Connection diagrams (pin side view)

Terminal (pin)	A1(1); A2(2)	22(3); 21(4); 24(5); 12(6); 11(7); 14(8)
[mm]	Ø 0,6	0,5 x 0,9
Drilling hole:		
• for relays Ø 1,3 + 0,1 mm		
• for sockets Ø 1,5 + 0,1 mm		

RM85 terminals are doubled for each contact.
Both terminals are to be used while connecting to load.

Connection of GZ.80 sockets

Note: loads above 12 A (GZT80, GZM80, GZP80) or 10 A (GZS80, GZF80) require bridging pairs of terminals: 11 with 21, 12 with 22, 14 with 24. Loads up to 12 A or 10 A do not require bridging of common terminals (such bridges may be fixed, however).

Mounting, sockets and accessories for relays

Relays **RM85** are designed for: • direct PCB mounting • plug-in sockets.

Sockets for RM85	Accessories			Additional equipment
	Retainer / retractor clips	Spring wire clips	Description plates	
Screw terminals sockets , 35 mm rail mount (acc. to EN 60715) or on panel mounting (one M3 screw)				
GZT80	GZT80-0040, GZP80-0400	GZM80-0041	GZT80-0035	M... , ZGGZ80
GZM80	GZT80-0040, GZP80-0400	GZM80-0041	GZT80-0035	M... , ZGGZ80
GZS80	GZS-0040	GZM80-0041	TR	M... , ZGGZ80
GZF80	–	GZM80-0041	–	–
Push-in terminals sockets , 35 mm rail mount (acc. to EN 60715) or on panel mounting (one M3 screw)				
GZP80	GZP80-0400, GZT80-0040	GZM80-0041	MP15	M... , ZGZP80-8, ZGZP80-2, ZGZP-2
Sockets for PCB				
PW80	–	MH16-2	–	–
EW50	–	MP16-2 , MH16-2	–	–
EC 50	–	MP16-2 , MH16-2	–	–
GD50	–	MP16-2 , MH16-2, GD-0016	–	–

④ For relays in transparent cover: the distance at least 5 mm between the relays mounted side by side. ⑤ Sockets GZ.80: load connection - see page 2. ⑥ Sockets GZP80: wire connection - see page 7. ⑦ Signalling / protecting modules type M... - see page 10. ⑧ Interconnection strips ZGGZ80, ZGZP.. - see pages 11-12. ⑨ Plastic clips MP16-2.

Electrical life at AC resistive load.
Switching frequency: 600 cycles/hour

Fig. 1

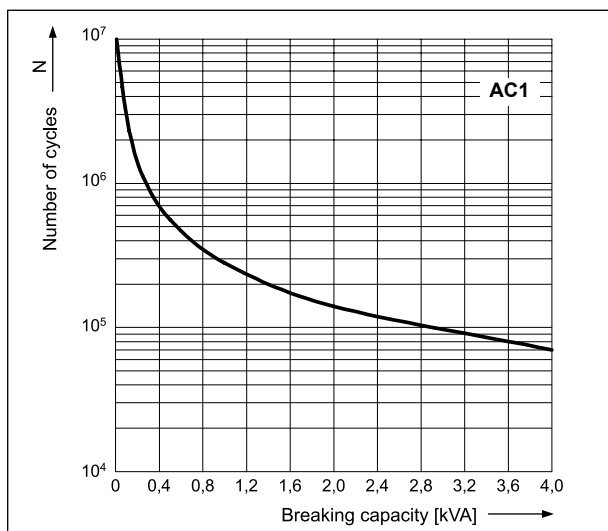

Electrical life reduction factor at AC inductive load

Fig. 2

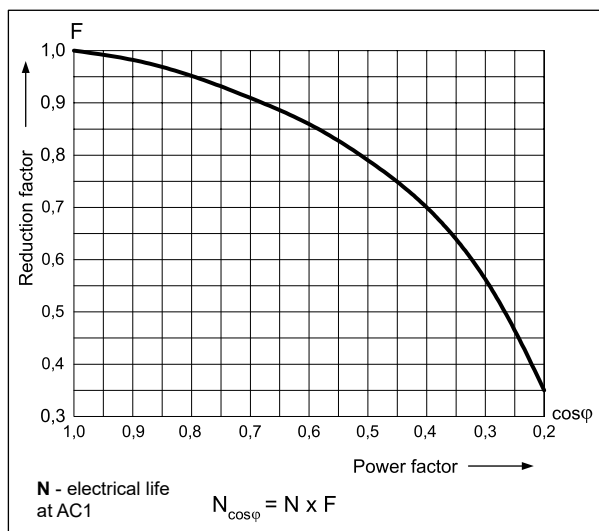

Max. DC resistive load breaking capacity

Fig. 3

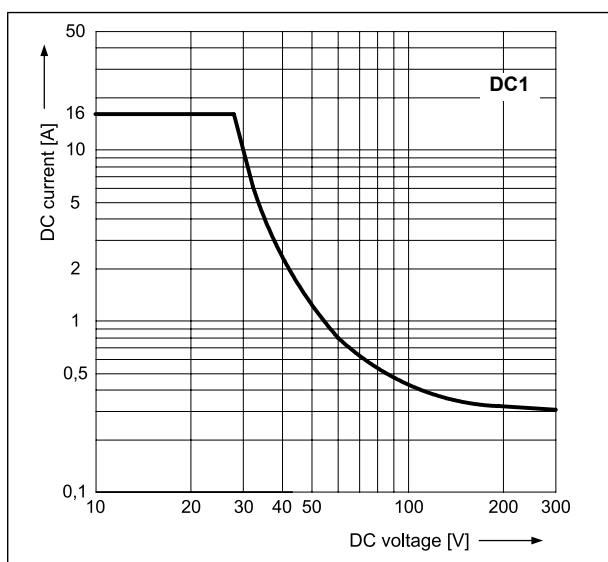

Coil operating range - DC

Fig. 4

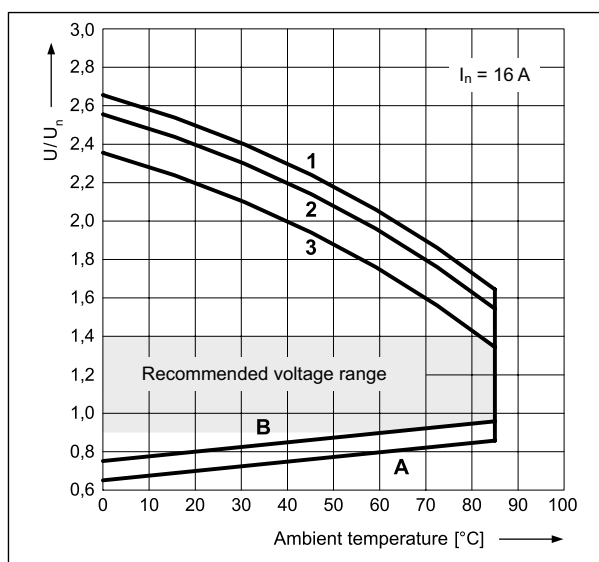

Coil operating range - AC 50 Hz

Fig. 5

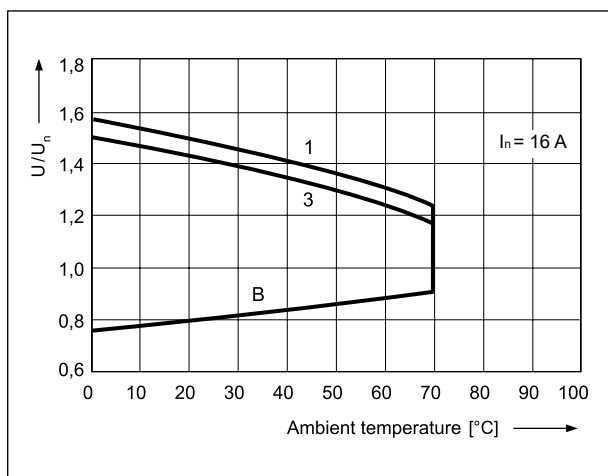

Description of Fig. 4 and 5

Using voltage other than the rated coil voltage may reduce the electrical life of the relay. Figure 4 shows the permissible voltage range for the relay coil, higher coil supply voltages may damage the coil insulation.

A - relations between make voltage and ambient temperature at no load on contacts. Coil temperature and ambient temperature are equal before coil energizing. Make voltage is not higher than the value read on Y axis (multiplication of rated voltage).

B - relations between make voltage and ambient temperature after initial coil heating up with $1,1 U_n$ at continues load of I_n on contacts. Make voltage is not higher than the value read on Y axis (multiplication of rated voltage).

1, 2, 3 - values on Y axis represent allowed overvoltage on coil at certain ambient temperature and contact load:

- 1** - no load
- 2** - 50% of rated load in AC1 category
- 3** - rated load in AC1 category

RM85

miniature relays

Dimensions

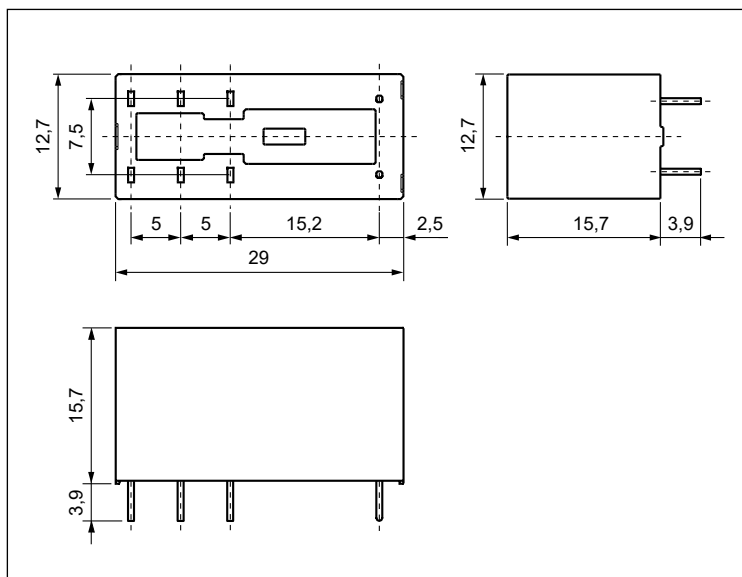

Pinout (solder side view)

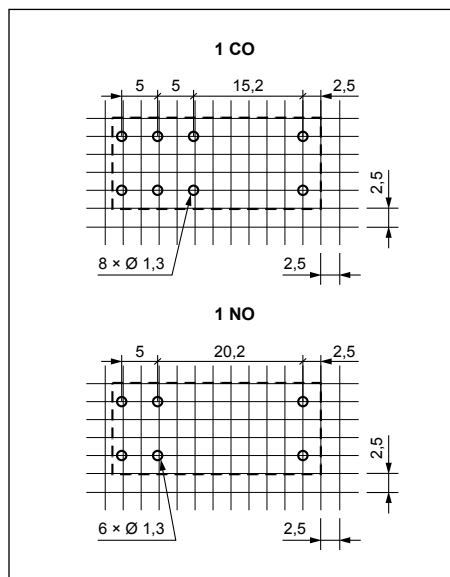

Coil data - DC voltage version

Table 1

Coil code	Rated voltage V DC	Coil resistance at 20 °C Ω	Acceptable resistance	Coil operating range V DC Ⓣ	
				min. (at 20 °C)	max. (at 20 °C)
1003	3	22	± 10%	2,1	7,6
1005	5	60	± 10%	3,5	12,7
1006	6	90	± 10%	4,2	15,3
1009	9	200	± 10%	6,3	22,9
1012	12	360	± 10%	8,4	30,6
1018	18	710	± 10%	12,6	45,9
1024	24	1 440	± 10%	16,8	61,2
1036	36	3 140	± 10%	25,2	91,8
1048	48	5 700	± 10%	33,6	122,4
1060	60	7 500	± 10%	42,0	153,0
1110	110	25 200	± 10%	77,0	280,0

The data in bold type relate to the standard versions of the relays. Ⓣ The coil parameters are given for 20 °C and a relay with no load on the contacts. See details in Figure 4: permissible operating voltage range of the coil - DC voltage.

Coil data - AC 50/60 Hz voltage version

Table 2

Coil code	Rated voltage V AC	Coil resistance at 20 °C Ω	Acceptable resistance	Coil operating range V AC 50 Hz	
				min. (at 20 °C)	max. (at 20 °C)
5012	12	100	± 10%	9,6	13,2
5024	24	400	± 10%	19,2	28,8
5048	48	1 550	± 10%	38,4	57,6
5060	60	2 600	± 10%	48,0	72,0
5110	110	8 900	± 10%	88,0	132,0
5115	115	9 600	± 10%	92,0	138,0
5120	120	10 200	± 10%	96,0	144,0
5220	220	35 500	± 10%	176,0	264,0
5230	230	38 500	± 10%	184,0	276,0
5240	240	42 500	± 15%	192,0	288,0

The data in bold type relate to the standard versions of the relays.

RM85

miniature relays

Ordering codes

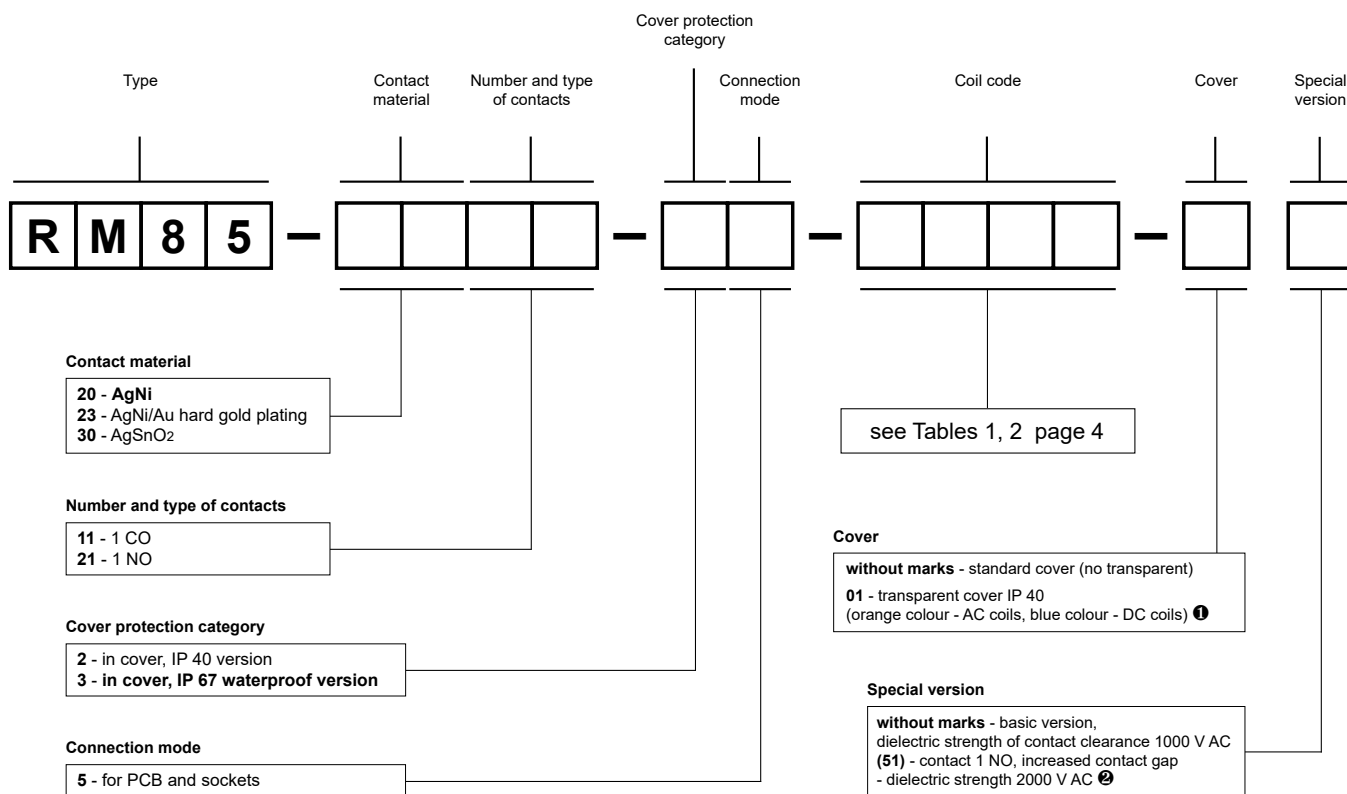

❶ 01: special version - relay in transparent cover (certifications cULus, EAC), only available with IP 40 and RTII, operating temperature -20...+70 °C
 ❷ (51): special version - relay with one normally open contact 1 NO, with increased contact gap - dielectric strength 2000 V AC, only available with DC coil

Examples of ordering code:

RM85-3011-25-5024

relay **RM85**, for PCB and sockets, one changeover contact, contact material AgSnO₂, coil voltage 24 V AC 50/60 Hz, in standard cover (no transparent) IP 40

RM85-2011-25-1012-01

relay **RM85**, for PCB and sockets, one changeover contact, contact material AgNi, coil voltage 12 V DC, in transparent cover (blue colour) IP 40

RM85-2321-35-1024 (51)

relay **RM85**, special version with increased contact gap, for PCB and sockets, one normally open contact, contact material AgNi/Au hard gold plating, coil voltage 24 V DC, in standard cover (no transparent) IP 67

RM85

Transparent cover IP 40,
certifications cULus, EAC
(orange colour - AC coils,
blue colour - DC coils)



Sockets and accessories

GZT80

For RM84, RM85, RM85 inrush, RM85 105 °C sensitive, RM87L, RM87L sensitive, RM87P, RM87P sensitive

Screw terminals
Max. tightening moment for the terminal: 0,7 Nm
35 mm rail mount acc. to EN 60715
or on panel mounting
80 x 15,6 x 61(67) mm
Two poles, 5 mm pinout
12 A, 300 V AC



Connection diagrams ③

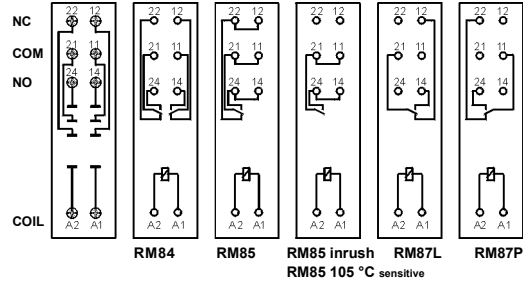

Accessories ① ZGGZ80 GZM80-0041

Dimensions

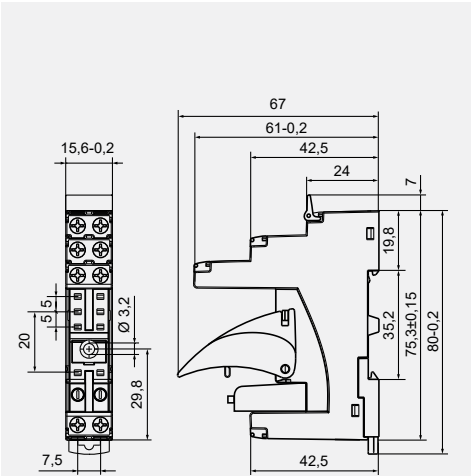

GZM80

For RM84, RM85, RM85 inrush, RM85 105 °C sensitive, RM87L, RM87L sensitive, RM87P, RM87P sensitive

Screw terminals
Max. tightening moment for the terminal: 0,7 Nm
35 mm rail mount acc. to EN 60715
or on panel mounting
81,6 x 15,9 x 61(67) mm
Two poles, 5 mm pinout
12 A, 300 V AC



Connection diagrams ③

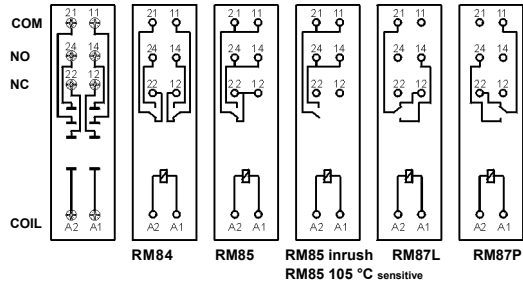

Accessories ① ZGGZ80 GZM80-0041

Dimensions

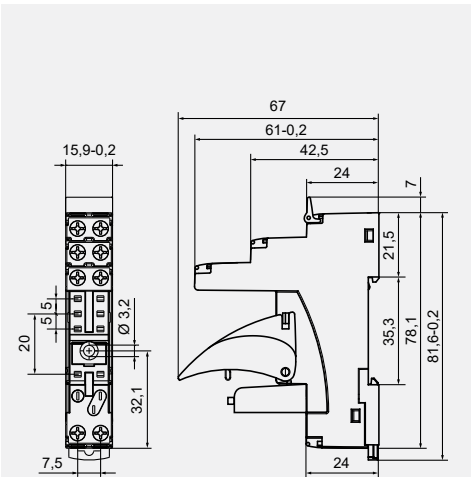

GZS80

For RM84, RM85, RM85 inrush, RM85 105 °C sensitive, RM87L, RM87L sensitive, RM87P, RM87P sensitive

Screw terminals
Max. tightening moment for the terminal: 0,5 Nm
35 mm rail mount acc. to EN 60715
or on panel mounting
76,8 x 15,8 x 42,5(57,1) mm
Two poles, 5 mm pinout
10 A, 300 V AC



Connection diagrams ③

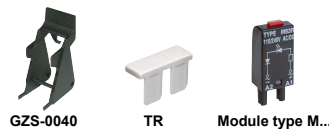
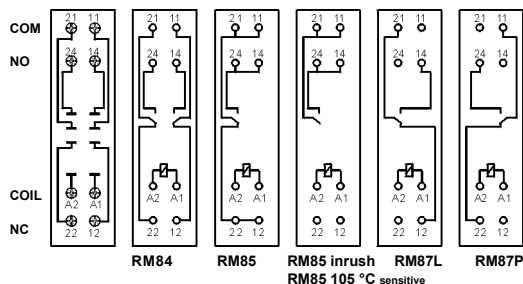

Accessories ① ZGGZ80 GZM80-0041

Dimensions

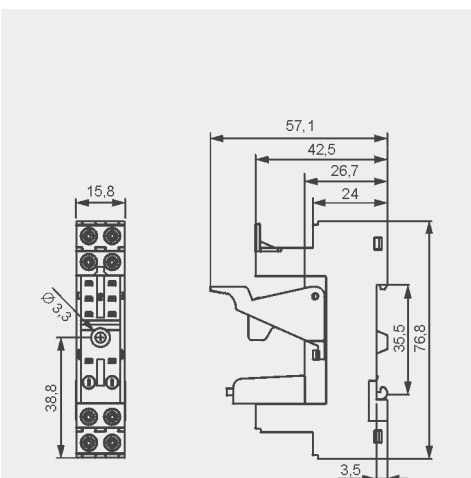

① Mounting and sub-assemblies of accessories in the socket - see page 8. Signalling / protecting modules type M... - see page 10. ② In the bracket the height of socket with retainer / retractor clip is shown. ③ For RM85..., RMP85: loads above 12 A (GZT80, GZM80, GZP80) or 10 A (GZS80, GZF80) require bridging pairs of terminals: 11 with 21, 12 with 22, 14 with 24 - see www.repol.com.pl

Sockets and accessories

GZP80

For RM84, RM85, RM85 inrush, RM85 105 °C sensitive, RM87L, RM87L sensitive, RM87P, RM87P sensitive, RMP84, RMP85

Push-in terminals (flammability class V-0)
Max. cross section of the cables:
2 x 1,5 mm² (ferrules without insulation)
2 x 1 mm² (ferrules with insulation)
Stripping length: 8... 10 mm

35 mm rail mount acc. to EN 60715 or on panel mounting
97 x 15,9 x 45,9(75,8) mm
5 mm pinout
One pole 12 A, 300 V AC
Two poles 8 A, 300 V AC

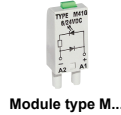

Accessories

Connection diagrams

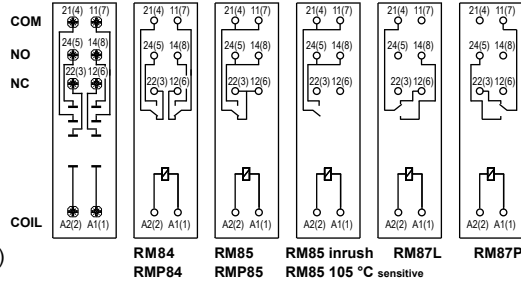

Dimensions

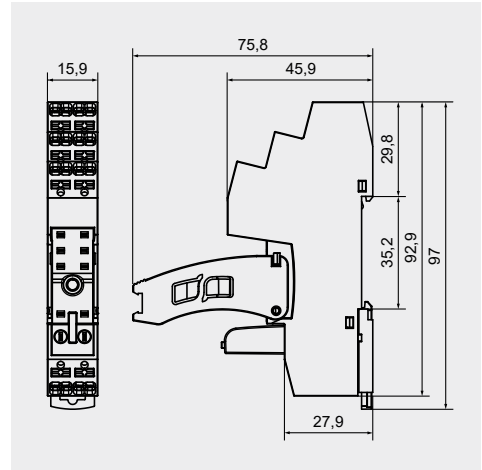

The drawings present inserting wire into the Push-in terminal and removing wire using the button releasing a clamp (assembly without tools).

Wire connection

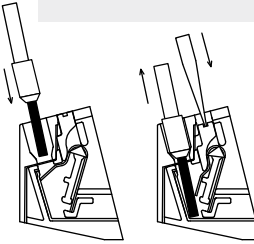

GZF80

For RM84, RM85, RM85 inrush, RM85 105 °C sensitive, RM87L, RM87L sensitive, RM87P, RM87P sensitive, RMP84, RMP85

Screw terminals
Max. tightening moment for the terminal: 0,5 Nm
35 mm rail mount acc. to EN 60715 or on panel mounting
67,2 x 15,5 x 36,5 mm
Two poles, 5 mm pinout
10 A, 250 V AC



Connection diagrams

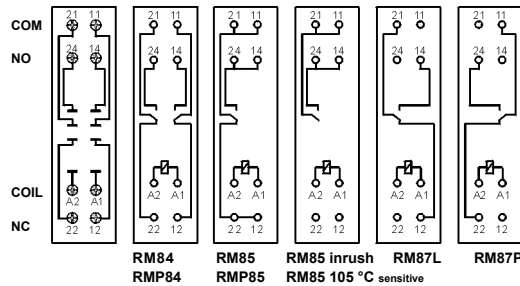

Dimensions

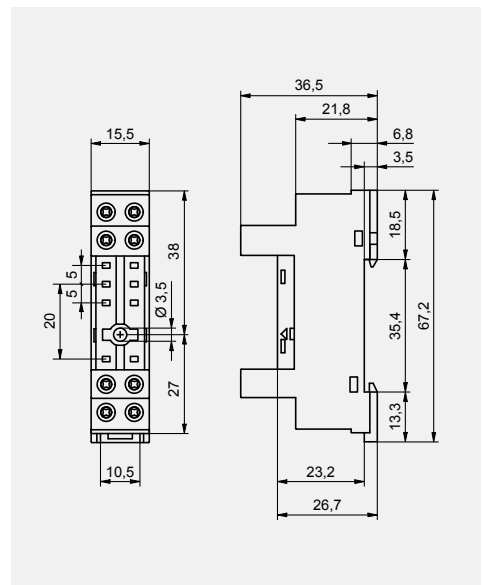

Accessories

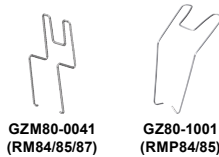

① Mounting and sub-assemblies of accessories in the socket - see page 8. Signalling / protecting modules type M... - see page 10. ② In the bracket the height of socket with retainer / retractor clip is shown. ③ For RM85..., RMP85: loads above 12 A (GZT80, GZM80, GZP80) or 10 A (GZS80, GZF80) require bridging pairs of terminals: 11 with 21, 12 with 22, 14 with 24 - see www.repol.com.pl



Mounting and sub-assemblies of the relay and accessories in the socket

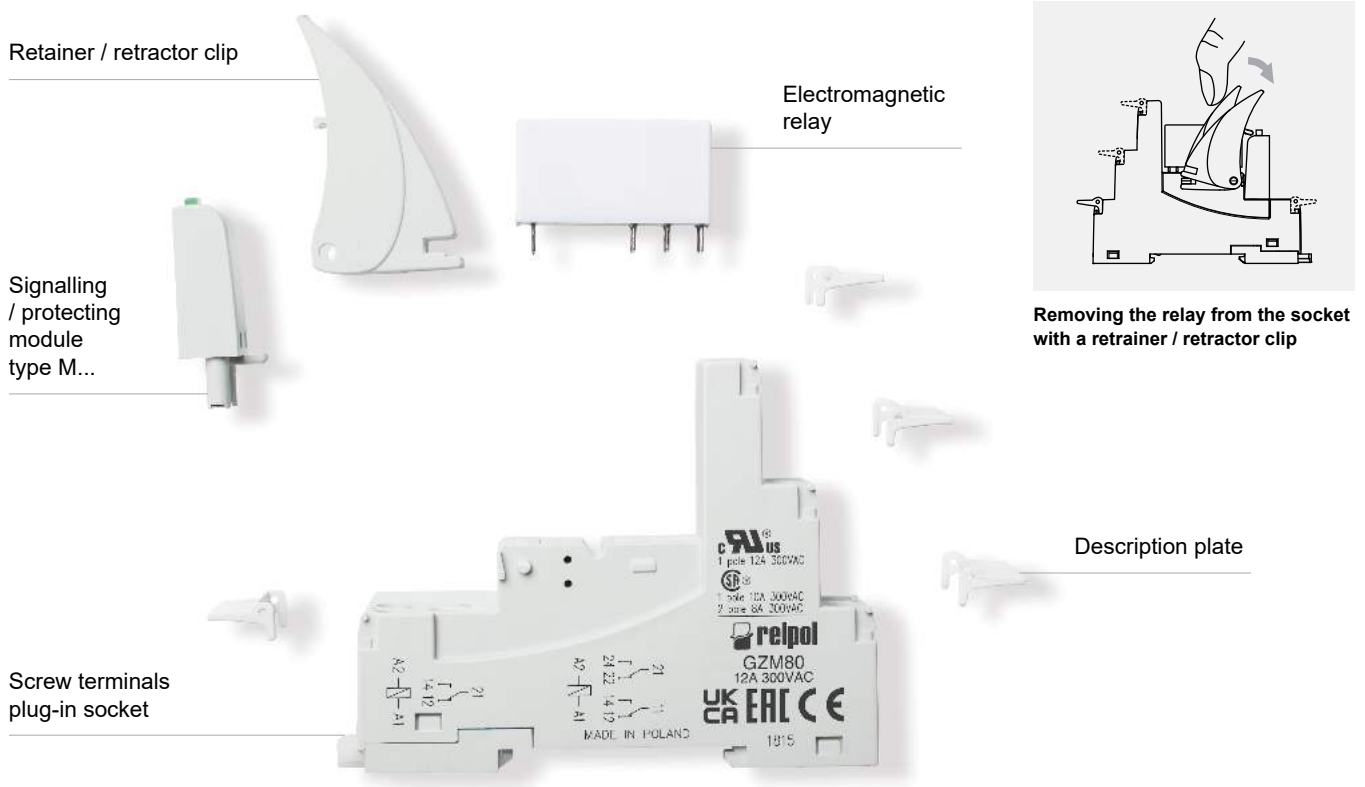

PRECAUTIONS:

1. Ensure that the parameters of the product described in its specification provide a safety margin for the appropriate operation of the device or system and never use the product in circumstances which exceed the parameters of the product. 2. Never touch any live parts of the device. 3. Ensure that the product has been connected correctly. An incorrect connection may cause malfunction, excessive heating or risk of fire. 4. In case of any risk of any serious material loss or death or injuries of humans or animals, the devices or systems shall be designed so to equip them with double safety system to guarantee their reliable operation.

Sockets and accessories

PW80

For RM84, RM85, RM85 inrush, RM85 105 °C sensitive, RM87L, RM87L sensitive, RM87P, RM87P sensitive, RM83

For PCB
34,6 x 12,9 x 6,6 mm
Two poles, 5 mm pinout
12 A, 250 V AC



Pinout

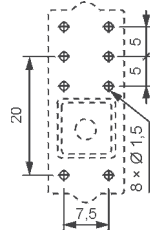

Accessories

Dimensions

ERC

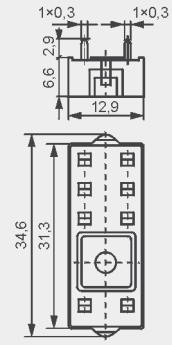

EW50

For RM84, RM85, RM85 inrush, RM85 105 °C sensitive, RM87L, RM87L sensitive, RM87P, RM87P sensitive, RM83, RMP84, RMP85

For PCB
30,2 x 13 x 9,4 mm
Two poles, 5 mm pinout
10 A, 250 V AC



Pinout

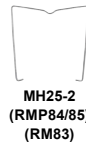
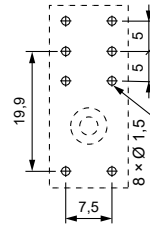

Accessories

Dimensions

ERC

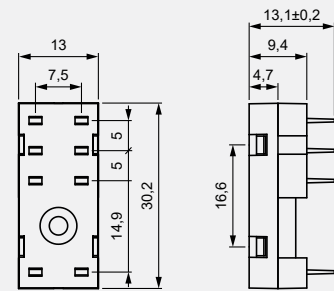

EC 50

For RM84, RM85, RM85 inrush, RM85 105 °C sensitive, RM87L, RM87L sensitive, RM87P, RM87P sensitive, RM83, RMP84, RMP85

For PCB
31,3 x 12,7 x 9 mm
Two poles, 5 mm pinout
12 A, 250 V AC



Pinout

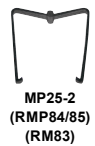
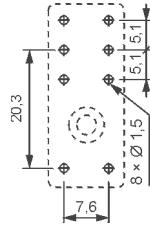

Accessories

Dimensions

ERC

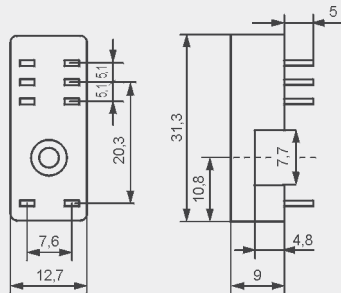

GD50

For RM84, RM85, RM85 inrush, RM85 105 °C sensitive, RM87L, RM87L sensitive, RM87P, RM87P sensitive, RM83, RMP84, RMP85

For PCB
31,5 x 13 x 9 mm
Two poles, 5 mm pinout
8 A, 300 V AC



Pinout

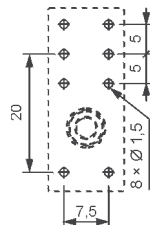

Accessories

Dimensions

ERC

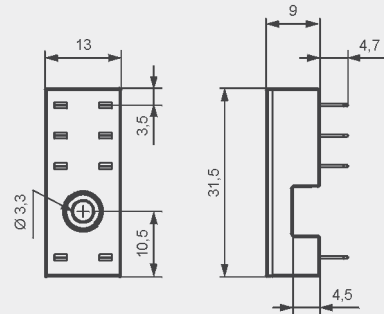

Signalling / protecting modules type M...

For sockets type:

GZT80, GZM80, GZS80, GZP80, GZT92, GZM92, GZS92, ES 32, GZT2, GZM2, GZT3, GZM3, GZT4, GZM4, GZP4

Modules type M... are parallelly connected with relay coil.

Polarization P: -A1/+A2. Polarization N: +A1/-A2.

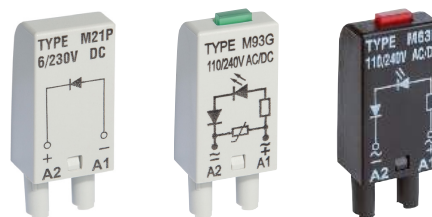

Modules type M...	Layout	Voltage	Type of module ① ②
Module D (polarization P) It limits overvoltage on DC coils.		6/230 V DC	M21P
Module D (polarization N) It limits overvoltage on DC coils.		6/230 V DC	M21N
Module LD (polarization P) It limits overvoltage on DC coils. Coil energizing indication.		6/24 V DC 24/60 V DC 110/230 V DC	M31R, M31G M32R, M32G M33R, M33G
Module LD (polarization N) It limits overvoltage on DC coils. Coil energizing indication.		6/24 V DC 24/60 V DC 110/230 V DC	M41R, M41G M42R, M42G M43R, M43G
Module RC It protects against EMC disturbance. It limits overvoltage.		6/24 V AC/DC 24/60 V AC/DC 110/240 V AC/DC	M51 M52 M53
Module L Coil energizing indication.		6/24 V AC/DC 24/60 V AC/DC 110/240 V AC/DC	M61R, M61G M62R, M62G M63R, M63G
Module LV It limits overvoltage on AC and DC coils. Coil energizing indication.		6/24 V AC/DC 24/60 V AC/DC 110/240 V AC/DC	M91R, M91G M92R, M92G M93R, M93G
Module V It limits overvoltage on AC coils. No indication.		6/24 V AC 110/130 V AC 220/240 V AC	M71 M72 M73
Module R It limits harmful voltage on AC coils induced in long lines which causes unwanted making of the relay.		110/240 V AC	M103

① M...R - LED red, M...G - LED green

② When ordering modules indicate their color: gray or black.

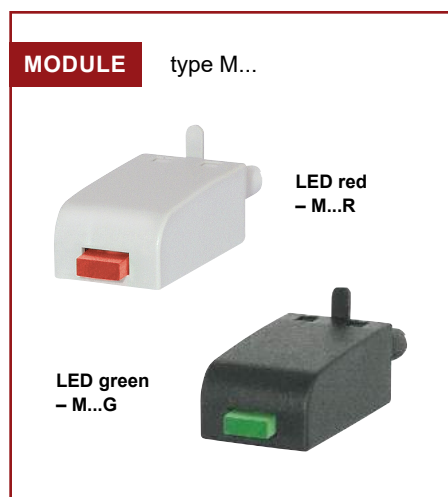

Interconnection strips ZGGZ80



PI85-...-MS-...
(RM85 + GZM80)

ZGGZ80

ZGGZ80 for:

Plug-in sockets	Relays for plug-in sockets	Interface relays ^③
GZT80	RM84, RM85, RM85 inrush, RM85 105 °C sensitive, RM87L ^④ , RM87P ^④ , RM87N ^④	PI84-...-TS-... (RM84 + GZT80)
GZM80		PI84-...-MS-... (RM84 + GZM80)
GZS80		PI85-...-TS-... (RM85 + GZT80)
GZT92		(RM85 inrush + GZT80)
GZM92		PI85-...-MS-... (RM85 + GZM80)
GZS92		
ES 32	RM96 1 CO	

^③ Interface relay **PI84 (PI85)** is offered as a **set**: electromagnetic relay **RM84 (RM85)** + plug-in socket **GZT80** or **GZM80** + signalling / protecting module type **M...** + retainer / retractor clip **GZT80-0040** + description plate **GZT80-0035**. ^④ Also versions RM87. sensitive

Interconnection strip ZGGZ80

- designed for the co-operation with plug-in sockets of miniature relays and with interface relays PI84 and PI85, which are equipped with screw terminals; sockets and relays are mounted on 35 mm rail mount acc. to EN 60715,
- bridges common input signals (coil terminals A1 or A2) or output signals - see photo at the top,
- maximum permissible current is 10 A / 250 V AC,
- possibility of connection of 8 sockets or relays,
- colours of strips: **ZGGZ80-1** grey, **ZGGZ80-2** black.

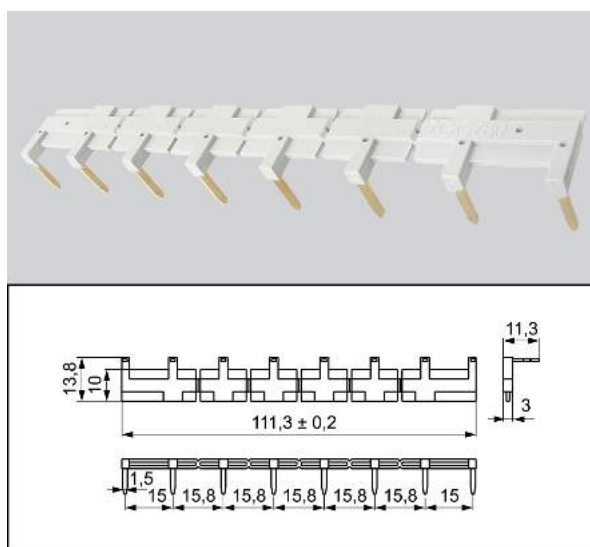

Interconnection strips ZGZP... for sockets GZP80

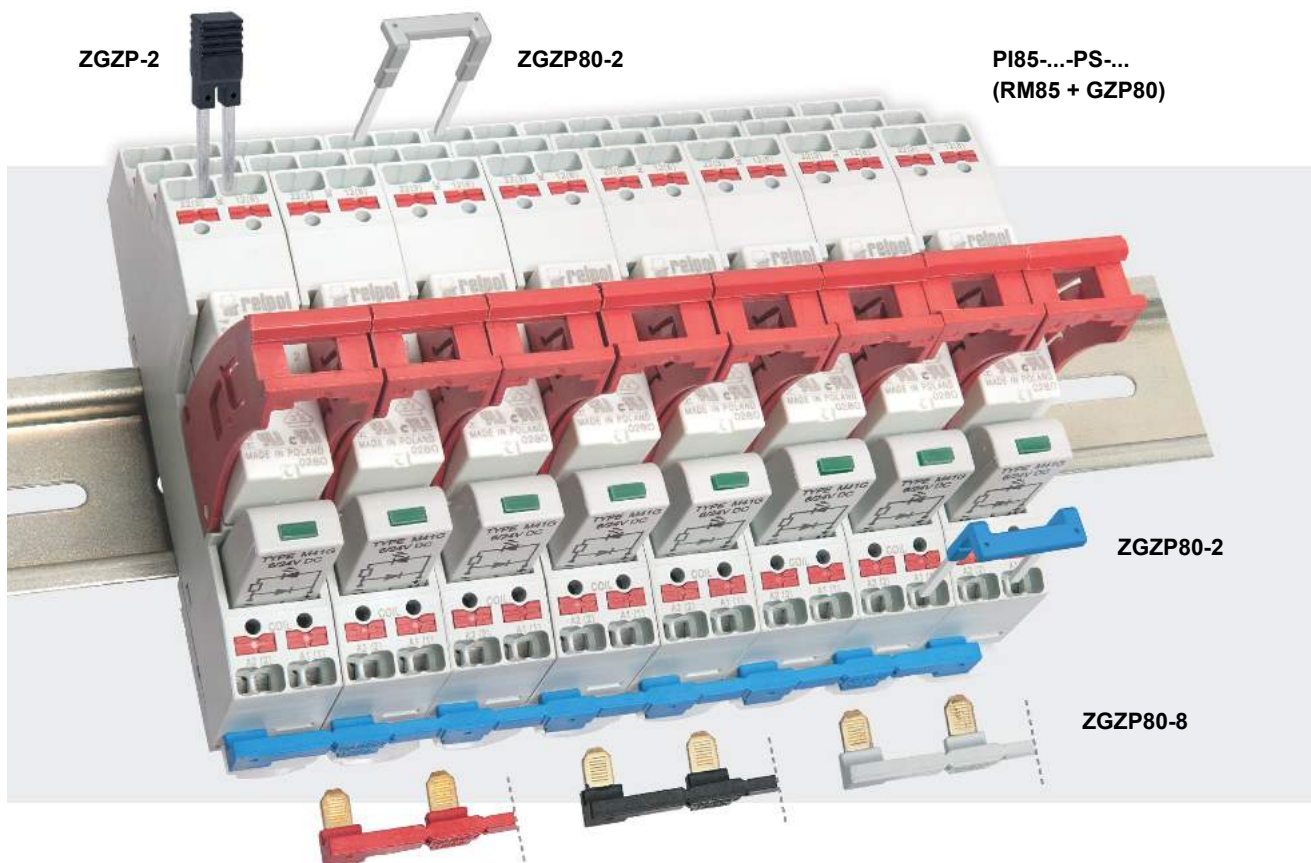

■ ZGZP... for:

Plug-in sockets	Relays for plug-in sockets	Interface relays ⑤
GZP80	RM84, RM85, RM85 inrush, RM85 105 °C sensitive, RM87L ④, RM87P ④, RMP84, RMP85	PI84-...-PS-... (RM84 + GZP80) PI85-...-PS-... (RM85 + GZP80) PI84P-...-PS-... (RMP84 + GZP80) PI85P-...-PS-... (RMP85 + GZP80)

⑤ Interface relay **PI84** (**PI85**, **PI84P**, **PI85P**) is offered as a **set**: electromagnetic relay **RM84** (**RM85**, **RMP84**, **RMP85**) + plug-in socket **GZP80** + signalling / protecting module type **M...** + retainer / retractor clip **GZP80-0400**.

④ Also versions RM87. sensitive

■ Interconnection strips ZGZP...

- designed for the co-operation with plug-in sockets of miniature relays and with interface relays PI84, PI85, PI84P, PI85P, which are equipped with Push-in terminals; sockets and relays are mounted on 35 mm rail mount acc. to EN 60715,
- strip **ZGZP80-8** bridges common input signals (coil terminals A1 or A2), maximum permissible current is 10 A / 250 V AC, possibility of connection of 8 sockets or relays,



- strip **ZGZP80-2** bridges common input signals (coil terminals A1 or A2) or output signals, possibility of connection of 2+n sockets or relays,



- jumper **ZGZP-2** bridges the neighboring poles of single socket **GZP80** (usage of jumpers ZGZP-2 in interface relays Push-in PI85, PI85P increases load capacity of socket from 12 A to 16 A).

